

SIEMENS

MICROMASTER 430

7,5 kW - 90 kW

Operating Instructions

Issue 03/02



SIEMENS

MICROMASTER 430

Operating Instructions
User Documentation

Valid for

Issue 03/02

Converter Type
MICROMASTER 430

Software Version
V2.0

Issue 03/02

Overview	1
Installation	2
Commissioning	3
MICROMASTER 430 Functions	4
System Parameters	5
Troubleshooting	6
MICROMASTER 430 Specifications	7
Available options	8
Electro-Magnetic Compatibility	9
Appendices	A B C D E F G H I J K L
Index	

Further information can be obtained from Internet website:

<http://www.siemens.de/micromaster>

Approved Siemens Quality for Software and Training is to DIN ISO 9001, Reg. No. 2160-01

The reproduction, transmission or use of this document, or its contents is not permitted unless authorized in writing. Offenders will be liable for damages. All rights including rights created by patent grant or registration of a utility model or design are reserved.

© Siemens AG 2001. All Rights Reserved.

MICROMASTER® is a registered trademark of Siemens

Other functions not described in this document may be available. However, this fact shall not constitute an obligation to supply such functions with a new control, or when servicing.

We have checked that the contents of this document correspond to the hardware and software described. There may be discrepancies nevertheless, and no guarantee can be given that they are completely identical. The information contained in this document is reviewed regularly and any necessary changes will be included in the next edition. We welcome suggestions for improvement.

Siemens handbooks are printed on chlorine-free paper that has been produced from managed sustainable forests. No solvents have been used in the printing or binding process.

Document subject to change without prior notice.

Order number: 6SE6400-5AC00-0BP0

Siemens-Aktiengesellschaft

Foreword

User Documentation



WARNING

Before installing and commissioning the inverter, you must read all safety instructions and warnings carefully including all the warning labels attached to the equipment. Make sure that the warning labels are kept in a legible condition and replace missing or damaged labels.

Information is also available from:

Technical Support Nuremberg

Tel: +49 (0) 180 5050 222

Fax: +49 (0) 180 5050 223

Email: techsupport@ad.siemens.de

Monday to Friday: 7:00 am to 5:00 pm (local time)

Internet Home Address

Customers can access technical and general information at:

<http://www.siemens.de/micromaster>

Contact address

Should any questions or problems arise while reading this manual, please contact the Siemens office concerned using the form provided at the back this manual.

Definitions and Warnings



DANGER

indicates an imminently hazardous situation which, if not avoided, will result in death or serious injury.



WARNING

indicates a potentially hazardous situation which, if not avoided, could result in death or serious injury.



CAUTION

used with the safety alert symbol indicates a potentially hazardous situation which, if not avoided, may result in minor or moderate injury.

CAUTION

used without safety alert symbol indicates a potentially hazardous situation which, if not avoided, may result in a property damage.

NOTICE

indicates a potential situation which, if not avoided, may result in an undesirable result or state.

NOTE

For the purpose of this documentation, "Note" indicates important information relating to the product or highlights part of the documentation for special attention.

Qualified personnel

For the purpose of this Instruction Manual and product labels, a "Qualified person" is someone who is familiar with the installation, mounting, start-up and operation of the equipment and the hazards involved.

He or she must have the following qualifications:

1. Trained and authorized to energize, de-energize, clear, ground and tag circuits and equipment in accordance with established safety procedures.
2. Trained in the proper care and use of protective equipment in accordance with established safety procedures.
3. Trained in rendering first aid.

PE
 = Ground

- ◆ PE – Protective Earth uses circuit protective conductors sized for short circuits where the voltage will not rise in excess of 50 Volts. This connection is normally used to ground the inverter.
- ◆  - Is the ground connection where the reference voltage can be the same as the Earth voltage. This connection is normally used to ground the motor.

Use for intended purpose only

The equipment may be used only for the application stated in the manual and only in conjunction with devices and components recommended and authorized by Siemens.

Safety Instructions

The following Warnings, Cautions and Notes are provided for your safety and as a means of preventing damage to the product or components in the machines connected. This section lists Warnings, Cautions and Notes, which apply generally when handling MICROMASTER 430 Inverters, classified as **General, Transport & Storage, Commissioning, Operation, Repair and Dismantling & Disposal**.

Specific Warnings, Cautions and Notes that apply to particular activities are listed at the beginning of the relevant chapters and are repeated or supplemented at critical points throughout these sections.

Please read the information carefully, since it is provided for your personal safety and will also help prolong the service life of your MICROMASTER 430 Inverter and the equipment you connect to it.

General



WARNING

- ◆ This equipment contains dangerous voltages and controls potentially dangerous rotating mechanical parts. Non-compliance with **Warnings** or failure to follow the instructions contained in this manual can result in loss of life, severe personal injury or serious damage to property.
- ◆ Only suitable qualified personnel should work on this equipment, and only after becoming familiar with all safety notices, installation, operation and maintenance procedures contained in this manual. The successful and safe operation of this equipment is dependent upon its proper handling, installation, operation and maintenance.
- ◆ Risk of electric shock. The DC link capacitors remain charged for five minutes after power has been removed. **It is not permissible to open the equipment until 5 minutes after the power has been removed.**
- ◆ **HP ratings are based on the Siemens 1LA motors and are given for guidance only; they do not necessarily comply with UL or NEMA HP ratings.**



CAUTION

- ◆ Children and the general public must be prevented from accessing or approaching the equipment!
- ◆ This equipment may only be used for the purpose specified by the manufacturer. Unauthorized modifications and the use of spare parts and accessories that are not sold or recommended by the manufacturer of the equipment can cause fires, electric shocks and injuries.

NOTICE

- ◆ Keep these operating instructions within easy reach of the equipment and make them available to all users
- ◆ Whenever measuring or testing has to be performed on live equipment, the regulations of Safety Code VBG 4.0 must be observed, in particular §8 "Permissible Deviations when Working on Live Parts". Suitable electronic tools should be used.
- ◆ Before installing and commissioning, please read these safety instructions and warnings carefully and all the warning labels attached to the equipment. Make sure that the warning labels are kept in a legible condition and replace missing or damaged labels.

Transport & Storage



WARNING

- ◆ Correct transport, storage, erection and mounting, as well as careful operation and maintenance are essential for proper and safe operation of the equipment.
-



CAUTION

- ◆ Protect the inverter against physical shocks and vibration during transport and storage. Also be sure to protect it against water (rainfall) and excessive temperatures (see *table on page 86*).
-

Commissioning



WARNING

- ◆ Work on the device/system by **unqualified** personnel or failure to comply with warnings can result in severe personal injury or serious damage to material. Only suitably qualified personnel trained in the setup, installation, commissioning and operation of the product should carry out work on the device/system.
 - ◆ Only permanently-wired input power connections are allowed. This equipment must be grounded (IEC 536 Class 1, NEC and other applicable standards).
 - ◆ If a Residual Current-operated protective Device (RCD) is to be used, it must be an RCD type B. Machines with a three-phase power supply, fitted with EMC filters, must not be connected to a supply via an ELCB (Earth Leakage Circuit-Breaker - see *DIN VDE 0160, section 5.5.2 and EN 50178 section 5.2.11.1*).
 - ◆ The following terminals can carry dangerous voltages even if the inverter is inoperative:
 - the power supply terminals L/L1, N/L2, L3
 - the motor terminals U, V, W
 - and the terminals DC+/B+, DC-, B- and DC/R+
 - ◆ This equipment must not be used as an 'emergency stop mechanism' (see *EN 60204, 9.2.5.4*)
-



CAUTION

The connection of power, motor and control cables to the inverter must be carried out as shown in Figure 2-7 on page 30, to prevent inductive and capacitive interference from affecting the correct functioning of the inverter.

Operation



WARNING

- ◆ MICROMASTERS operate at high voltages.
 - ◆ When operating electrical devices, it is impossible to avoid applying hazardous voltages to certain parts of the equipment.
 - ◆ Emergency Stop facilities according to EN 60204 IEC 204 (VDE 0113) must remain operative in all operating modes of the control equipment. Any disengagement of the Emergency Stop facility must not lead to uncontrolled or undefined restart.
 - ◆ Wherever faults occurring in the control equipment can lead to substantial material damage or even grievous bodily injury (i.e. potentially dangerous faults), additional external precautions must be taken or facilities provided to ensure or enforce safe operation, even when a fault occurs (e.g. independent limit switches, mechanical interlocks, etc.).
 - ◆ Certain parameter settings may cause the inverter to restart automatically after an input power failure.
 - ◆ Motor parameters must be accurately configured for motor overload protection to operate correctly.
 - ◆ This equipment is capable of providing internal motor overload protection in accordance with UL508C section 42. Refer to P0610 and P0335, i²t is ON by default. Motor overload protection can also be provided using an external PTC (disabled by default P0601).
 - ◆ This equipment is suitable for use in a circuit capable of delivering not more than 10,000 symmetrical amperes (rms), for a maximum voltage of 460V when protected by a H or K type fuse (see *Tables starting on page 87*).
 - ◆ This equipment must not be used as an 'emergency stop mechanism' (see *EN 60204, 9.2.5.4*)
-

Repair



WARNING

- ◆ Repairs on equipment may only be carried out by **Siemens Service**, by repair centers **authorized by Siemens** or by qualified personnel who are thoroughly acquainted with all the warnings and operating procedures contained in this manual.
 - ◆ Any defective parts or components must be replaced using parts contained in the relevant spare parts list.
 - ◆ Disconnect the power supply across all poles before opening the equipment for access
-

Dismantling & Disposal

CAUTION

- ◆ The inverter's packaging is re-usable. Retain the packaging for future use or return it to the manufacturer.
 - ◆ Easy-to-release screw and snap connectors allow you to break the unit down into its component parts. You can then re-cycle these component parts, dispose of them in **accordance with local requirements or return them to the manufacturer.**
-

Table of Contents

1	Overview	15
1.1	The MICROMASTER 430	16
1.2	Features	17
2	Installation	19
2.1	General.....	21
2.2	Ambient operating conditions.....	21
2.3	Mechanical installation	23
2.4	Electrical installation.....	25
3	Commissioning	31
3.1	Block diagram.....	33
3.2	Commission modes.....	34
3.3	General operation.....	45
4	MICROMASTER 430 functions	47
4.1	Frequency set point (P1000).....	48
4.2	Command sources (P0700)	49
4.3	OFF and brake function	49
4.4	Control modes (P1300)	51
4.5	MICROMASTER 430 operating modes	52
4.6	Faults and Alarms	56
5	System parameters	57
5.1	Introduction to MICROMASTER system parameters.....	58
5.2	Parameter overview	59
5.3	Parameter list (short form)	60
6	Troubleshooting	73
6.1	Troubleshooting with the SDP.....	74
6.2	Troubleshooting with the BOP-2	75
6.3	Fault messages	76
6.4	Alarm messages.....	80
7	MICROMASTER 430 specifications	85
8	Options	91
8.1	Device-independent options.....	91
8.2	Device-dependent options	91
9	Electro-magnetic compatibility (EMC)	93

9.1	Electro-magnetic compatibility	94
Appendices.....		97
A	Changing the Operator Panel	97
B	Removing Covers Frame Size C	98
C	Removing Covers Frame Sizes D and E	99
D	Removing Covers Frame Size F	100
E	Removing the I/O Board	101
F	Removing 'Y' Cap Frame Size C	102
G	Removing 'Y' Cap Frame Sizes D and E	103
H	Removing 'Y' Cap Frame Sizes F	104
I	Applicable Standards.....	105
J	List of Abbreviations.....	106
Index	107

List of Illustrations

Figure 2-1	Forming.....	21
Figure 2-2	Ambient operating temperature	21
Figure 2-3	Installation altitude	22
Figure 2-4	Drill pattern for MICROMASTER 430.....	24
Figure 2-5	MICROMASTER 430 Connection Terminals	27
Figure 2-6	Motor and Power Connections.....	28
Figure 2-7	Wiring Guidelines to Minimize the Effects of EMI	30
Figure 3-1	Inverter block diagram	33
Figure 3-2	Panels available for the MICROMASTER 430 Inverter.....	34
Figure 3-3	DIP switch.....	34
Figure 3-4	Basic operation with SDP	36
Figure 3-5	Buttons on the BOP-2.....	39
Figure 3-6	Changing parameters via the BOP-2	40
Figure 3-7	Typical Motor Rating Plate Example.....	44
Figure 4-1	Bypass circuit.....	52
Figure 4-2	Belt Failure Detection	53
Figure 4-3	Motor Staging	54
Figure 4-4	Energy Saving Mode	55
Figure 5-1	Parameter Overview	59

List of Tables

Table 2-1	Dimensions and Torques of MICROMASTER 430	23
Table 3-1	Default settings for operation using the SDP	35
Table 3-2	Default settings for operation using the BOP-2.....	38
Table 6-1	Inverter conditions indicated by the LEDs on the SDP	74
Table 7-1	MICROMASTER 430 Performance Ratings	86
Table 7-2	Tightening torques for power terminals.....	87
Table 7-3	MICROMASTER 430 Specifications.....	87
Table 9-1	General Industrial (unfiltered inverters together with approved external mains filter)	95
Table 9-2	Filtered Industrial	95
Table 9-3	Filtered for Residential, Commercial and Light Industry	96
Table 9-4	Compliance Table.....	96

1 Overview

This Chapter contains:

A summary of the major features of the MICROMASTER 430 range.

1.1	The MICROMASTER 430	16
1.2	Features	16

1.1 The MICROMASTER 430

The MICROMASTER 430s are a range of 3AC-frequency inverters for controlling the speed of three phase AC motors. The various models available range from the 7,5 kW input to the 90 kW input.

The MICROMASTER 430 is especially well suited for use with pumps and ventilators when used with its factory set functions and settings.

The inverters are microprocessor-controlled and use state-of-the-art Insulated Gate Bipolar Transistor (IGBT) technology. This makes them reliable and versatile. A special pulse-width modulation method with selectable Pulse frequency permits quiet motor operation. Comprehensive protective functions provide excellent inverter and motor protection.

1.2 Features

Main Characteristics

- Easy installation
- Easy commissioning
- Rugged EMC design
- Can be operated on IT line supplies
- Fast repeatable response time to control signals
- Comprehensive range of parameters enabling configuration for a wide range of applications
- Simple cable connection
- Output relays
- Analog outputs (0 – 20 mA)
- 6 Isolated and switchable NPN/PNP digital inputs
- 2 Analog inputs:
 - ◆ AIN1: 0 – 10 V, 0 – 20 mA and -10 to +10 V
 - ◆ AIN2: 0 – 10 V, 0 – 20 mA
- The 2 analog inputs can be used as the 7th and 8th digital inputs
- BiCo technology
- Modular design for extremely flexible configuration
- High switching frequencies for low-noise motor operation
- Detailed status information and integrated message functions
- External options for PC communications, Basic Operator Panel (BOP-2) and PROFIBUS communications module
- Pump & Fan Features:
 - ◆ Motor Staging (Control of additional drives via output relay)
 - ◆ Energy Saving Mode
 - ◆ Hand / Auto (manual / automatic)
 - ◆ Belt failure detection (detects if pumps have run dry)
 - ◆ Bypass

Performance Characteristics

- U/f control
 - ◆ Linear U/f control with flux current control (FCC) for improved dynamic response and motor control
 - ◆ Multiple point U/f control
- Fast Current Limitation (FCL) for trip-free operation
- Built-in DC injection brake
- Compound braking to improve braking performance
- Ramp function generator
 - ◆ With smoothing
 - ◆ Without smoothing
- Technology controller (PID)
- parameter set switch-over
 - ◆ Motor data sets (DDS)
 - ◆ Command data sets and setpoint sources (CDS)
- Rating for operation with variable torque (VT)

Protection characteristics

- Overvoltage/undervoltage protection
- Overtemperature protection for the inverter
- Ground fault protection
- Short-circuit protection
- i^2t thermal motor protection
- PTC/KTY for motor protection

2 Installation

This Chapter contains:

- General data relating to installation
- Dimensions of Inverter
- Wiring guidelines to minimize the effects of EMI
- Details concerning electrical installation

2.1	General.....	21
2.2	Ambient operating conditions.....	21
2.3	Mechanical installation.....	23
2.4	Electrical installation.....	25



WARNING

- ◆ Work on the device/system by **unqualified** personnel or failure to comply with warnings can result in severe personal injury or serious damage to material. Only suitably qualified personnel trained in the setup, installation, commissioning and operation of the product should carry out work on the device/system.
 - ◆ Only permanently-wired input power connections are allowed. This equipment must be grounded (IEC 536 Class 1, NEC and other applicable standards).
 - ◆ If a Residual Current-operated protective Device (RCD) is to be used, it must be an RCD type B. Machines with a three-phase power supply, fitted with EMC filters, must not be connected to a supply via an ELCB (Earth Leakage Circuit-Breaker EN 50178 Section 5.2.11.1).
 - ◆ The following terminals can carry dangerous voltages even if the inverter is inoperative:
 - the power supply terminals L/L1, N/L2, L3
 - the motor terminals U, V, W
 - and the terminals DC+/B+, DC-, B- and DC/R+
 - ◆ Always wait **5 minutes** to allow the unit to discharge after switching off before carrying out any installation work.
 - ◆ This equipment must not be used as an 'emergency stop mechanism' (see *EN 60204, 9.2.5.4*)
 - ◆ The minimum size of the earth-bonding conductor must be equal to or greater than the cross-section of the power supply cables.
-

CAUTION

The connection of power, motor and control cables to the inverter must be carried out as shown in Figure 2-7 on page 30, to prevent inductive and capacitive interference from affecting the correct functioning of the inverter.

2.1 General

Installation after a Period of Storage

Following a prolonged period of storage, you must reform the capacitors in the inverter. The requirements are listed below.

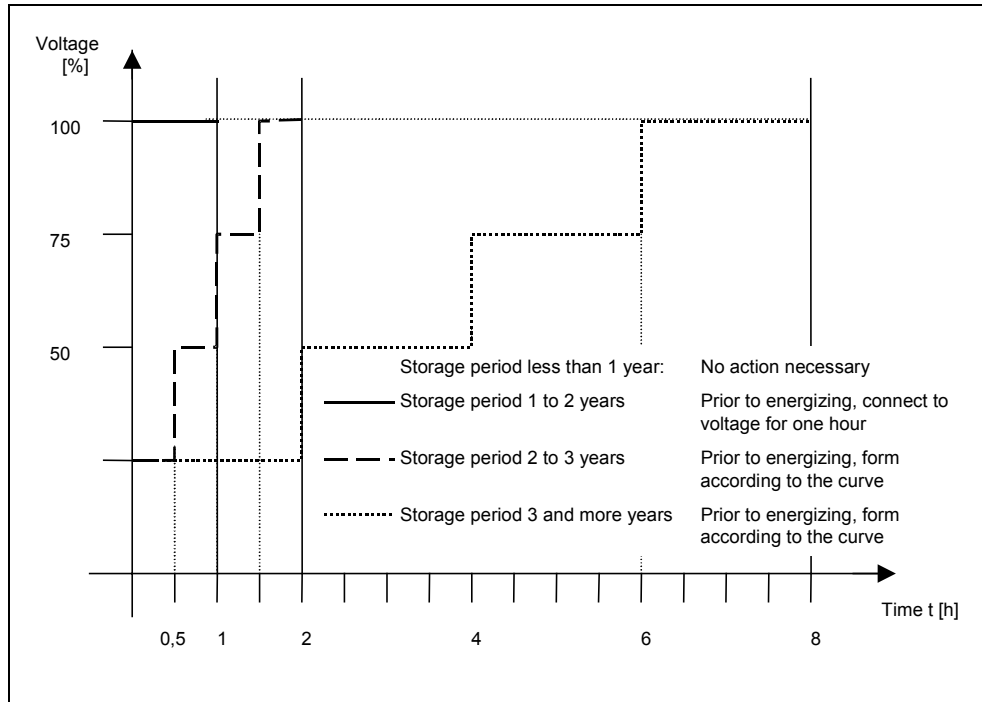

Figure 2-1 Forming

2.2 Ambient operating conditions

Temperature

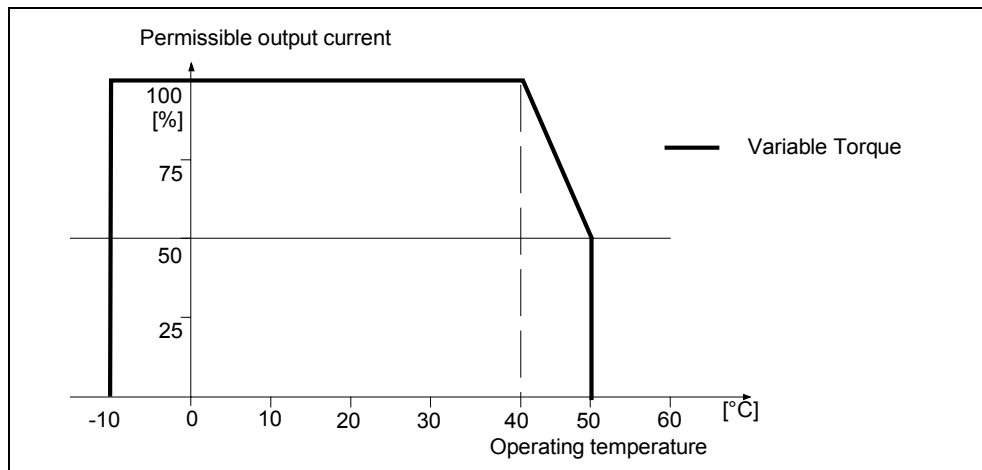

Figure 2-2 Ambient operating temperature

Humidity Range

Relative air humidity $\leq 95\%$ Non-condensing

Altitude

If the inverter is to be installed at an altitude > 1000 m or > 2000 m above sea level, derating will be required:

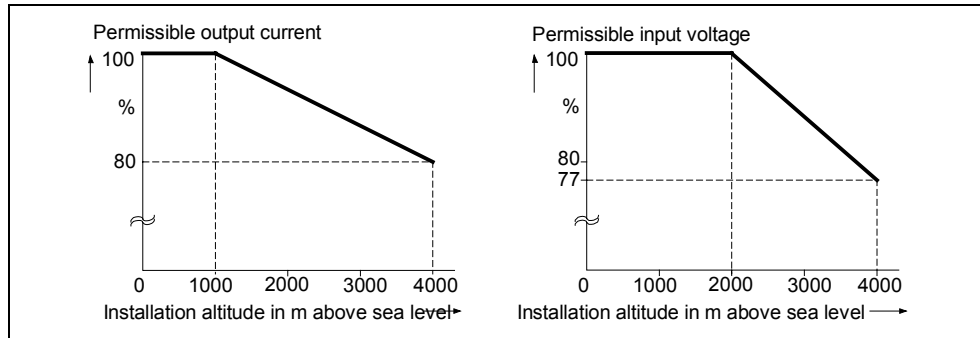

Figure 2-3 Installation altitude

Shock and Vibration

Do not drop the inverter or expose to sudden shock. Do not install the inverter in an area where it is likely to be exposed to constant vibration.

Mechanical strength to DIN IEC 68-2-6

- Deflection: 0.075 mm (10 ... 58 Hz)
- Acceleration: 9.8 m/s² (> 58 ... 500 Hz)

Electromagnetic Radiation

Do not install the inverter near sources of electromagnetic radiation.

Atmospheric Pollution

Do not install the inverter in an environment, which contains atmospheric pollutants such as dust, corrosive gases, etc.

Water

Take care to site the inverter away from potential water hazards, e.g. do not install the inverter beneath pipes that are subject to condensation. Avoid installing the inverter where excessive humidity and condensation may occur.

Installation and cooling

CAUTION

The inverters **MUST NOT** be mounted horizontally.

The inverters can be mounted without any clearance at either side.

The following clearances above and below the inverter are necessary:

- FS C 100 mm
- FS D, E 300 mm
- FS F 350 mm

When mounting one inverter above the other, the ambient operating temperature must be adhered to. Make sure that the cooling vents in the inverter are positioned correctly to allow free movement of air.

2.3 Mechanical installation



WARNING

- ◆ To ensure the safe operation of the equipment, it must be installed and commissioned by qualified personnel in full compliance with the warnings laid down in these operating instructions.
- ◆ Take particular note of the general and regional installation and safety regulations regarding work on dangerous voltage installations (e.g. EN 50178), as well as the relevant regulations regarding the correct use of tools and personal protective equipment (PPE).
- ◆ The mains input, DC and motor terminals, can carry dangerous voltages even if the inverter is inoperative; wait 5 minutes to allow the unit to discharge after switching off before carrying out any installation work.
- ◆ The inverters may only be fitted side by side. The following clearances above and below the inverter are necessary:
 - FS C 100 mm
 - FS D, E 300 mm
 - FS F 350 mm
- ◆ When mounting one inverter above the other, the ambient operating temperature must be adhered to.

Table 2-1 Dimensions and Torques of MICROMASTER 430

Frame-Size		Overall Dimensions		Fixing Method	Tightening Torque
C	Width x Height x Depth	mm	185 x 245 x 195	4 x M5 Bolts 4 x M5 Nuts 4 x M5 Washers	2.5 Nm with washers fitted
		inch	7.28 x 9.65 x 7.68		
D	Width x Height x Depth	mm	275 x 520 x 245	4 x M8 Bolts 4 x M8 Nuts 4 x M8 Washers	3.0 Nm with washers fitted
		inch	10.82 x 20.47 x 9.65		
E	Width x Height x Depth	mm	275 x 650 x 245	4 x M8 Bolts 4 x M8 Nuts 4 x M8 Washers	3.0 Nm with washers fitted
		inch	10.82 x 25.59 x 9.65		
F	Width x Height x Depth	mm	350 x 850 mm x 320 height with filter 1150	4 x M8 Bolts 4 x M8 Nuts 4 x M8 Washers	3.0 Nm with washers fitted
		inch	13.78 x 33.46 x 12.60 height with filter 45.28		

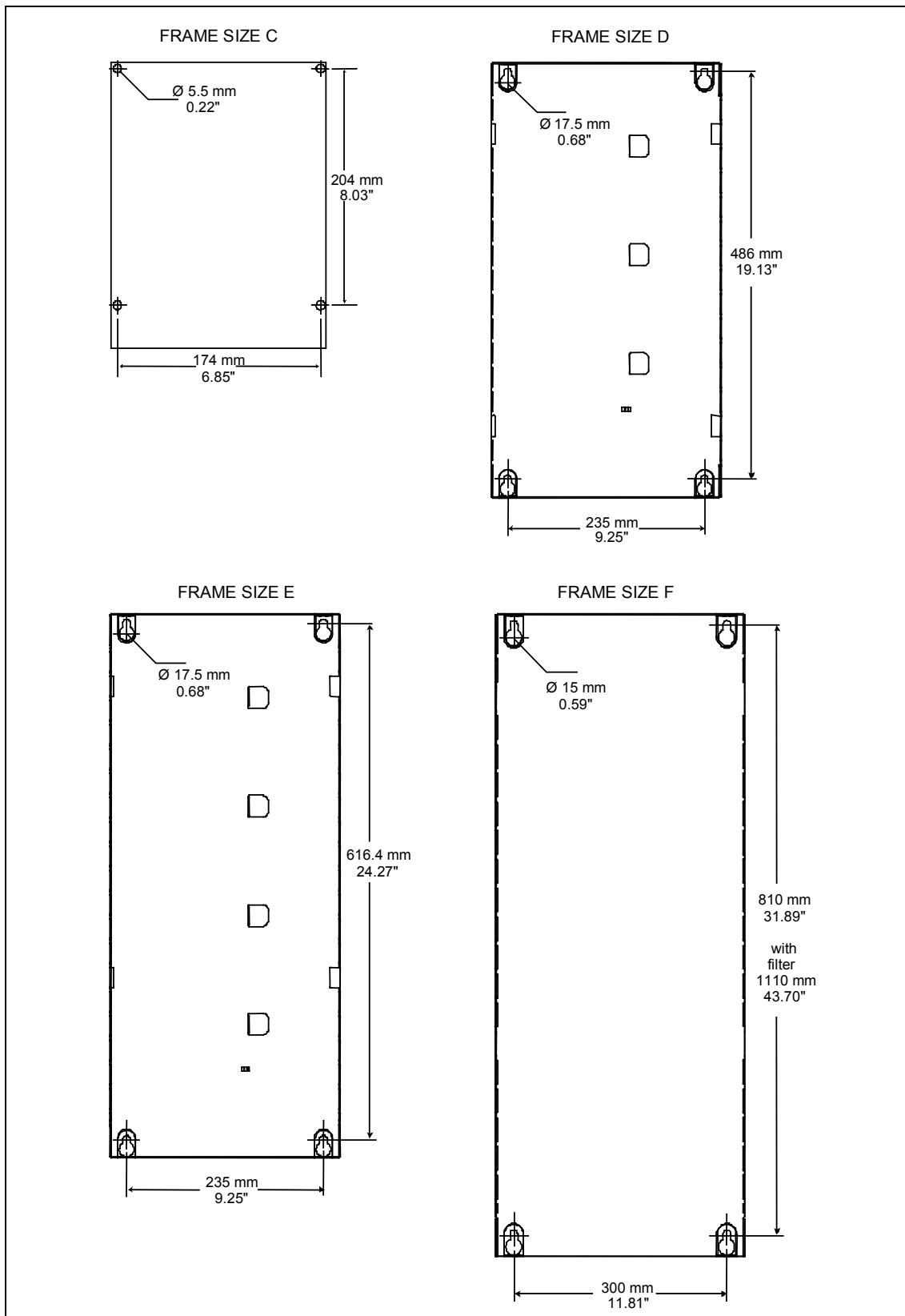

Figure 2-4 Drill pattern for MICROMASTER 430

2.4 Electrical installation



WARNING

The inverter must always be grounded.

- ◆ To ensure the safe operation of the equipment, it must be installed and commissioned by qualified personnel in full compliance with the warnings laid down in these operating instructions.
- ◆ Take particular note of the general and regional installation and safety regulations regarding work on dangerous voltage installations (e.g. EN 50178), as well as the relevant regulations regarding the correct use of tools and personal protective gear.
- ◆ Never use high voltage insulation test equipment on cables connected to the inverter.
- ◆ The mains input, DC and motor terminals, can carry dangerous voltages even if the inverter is inoperative; wait **5 minutes** to allow the unit to discharge after switching off before carrying out any installation work.

CAUTION

The control, power supply and motor leads **must** be laid separately. Do not feed them through the same cable conduit/trunking.

2.4.1 General



WARNING

The inverter must always be grounded. If the inverter is not grounded correctly, extremely dangerous conditions may arise within the inverter which could prove potentially fatal.

Operation with ungrounded (IT) supplies

The use of MICROMASTER 4 inverters with built in filters is not allowed on IT supplies.

On ungrounded supplies, it will be necessary to remove the 'Y' capacitor from the inside of the unit and fit an output choke. The procedure for removing this capacitor is described in Appendices E to H.

The MICROMASTER will operate from ungrounded supplies and will continue to operate if an input phase is shorted to ground. If an output phase is shorted to ground, the MICROMASTER will trip and indicate F0001.

Operation with Residual Current Device

If an RCD (also referred to as ELCB or RCCB) is fitted, the MICROMASTER inverters will operate without nuisance tripping, provided that:

- A type B RCD is used.
- The trip limit of the RCD is 300mA.
- The neutral of the supply is grounded.
- Only one inverter is supplied from each RCD.
- The output cables are less than 50m (screened) or 100m (unscreened).

Operation with long cables

All inverters will operate at full specification with cable lengths up to 50 m screened or 100 m unscreened.

The following cable lengths are possible using the output chokes specified in catalogue DA 51.2 :

- screened: 200 m
- unscreened: 300 m

2.4.2 Power and motor connections



WARNING

The inverter must always be grounded.

- ◆ Isolate the mains electrical supply before making or changing connections to the unit.
 - ◆ When synchronous motors are connected or when coupling several motors in parallel, the inverter must be operated with voltage/frequency control characteristic (P1300 = 0, 2 or 3).
-



CAUTION

After connecting the power and motor cables to the proper terminals, make sure that the covers have been replaced properly before supplying power to the unit!

NOTICE

- ◆ Ensure that the appropriate circuit-breakers/fuses with the specified current rating are connected between the power supply and inverter (*see chapter 7, Tables starting on page 87*).
 - ◆ Use Class 1 60/75°C copper wire only (for UL compliance). For tightening torque see Table 7-2 on page 87.
-

Access to the power and motor terminals

You can gain access to the mains and motor terminals by removing the covers (see also Appendices B to D).

The mains and motor connections must be made as shown in Figure 2-6.

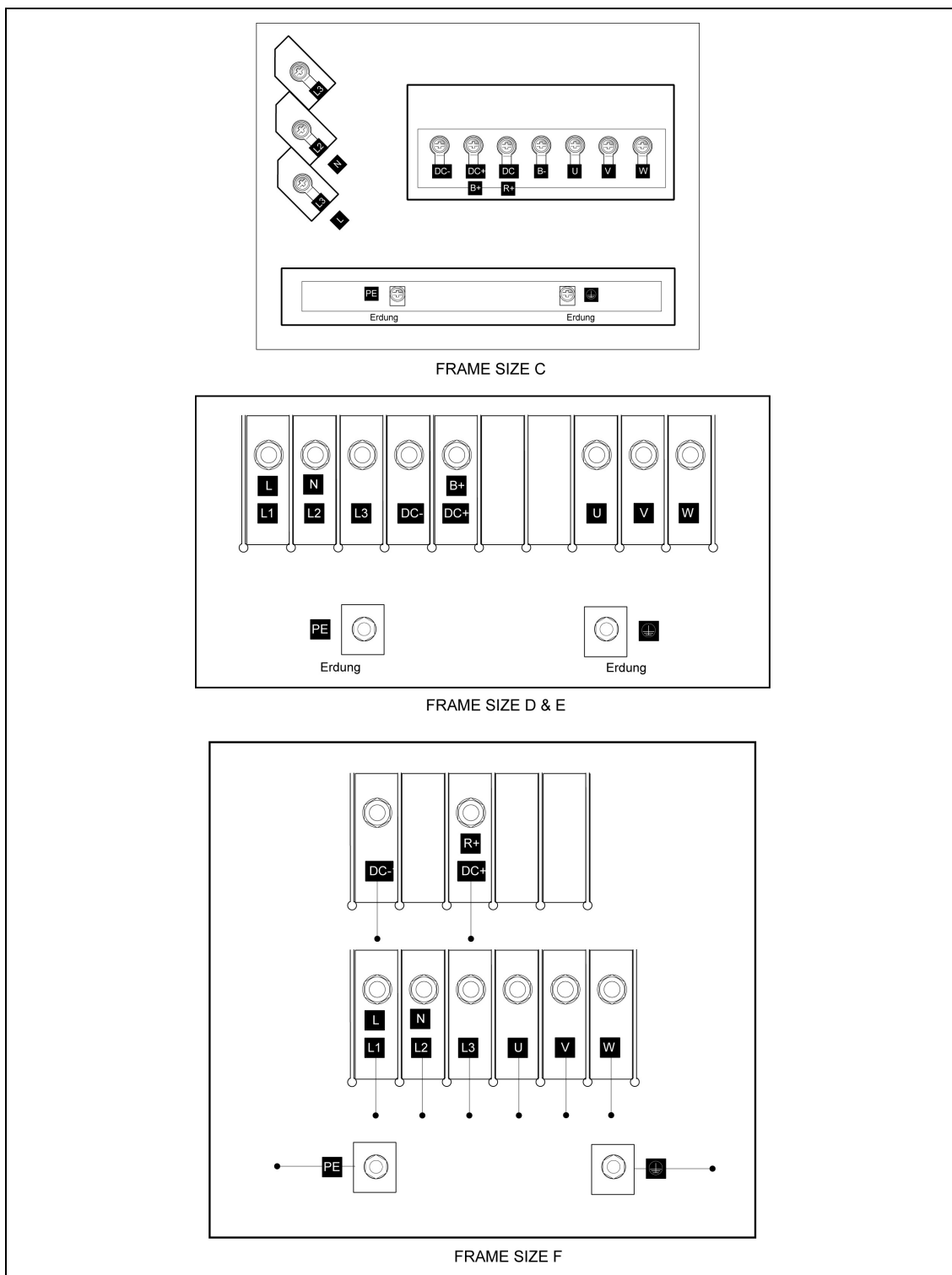

Figure 2-5 MICROMASTER 430 Connection Terminals

NOTE

The DC connections are for testing purposes only and have not been released for operation by the user. No brake resistors etc. may be connected here.

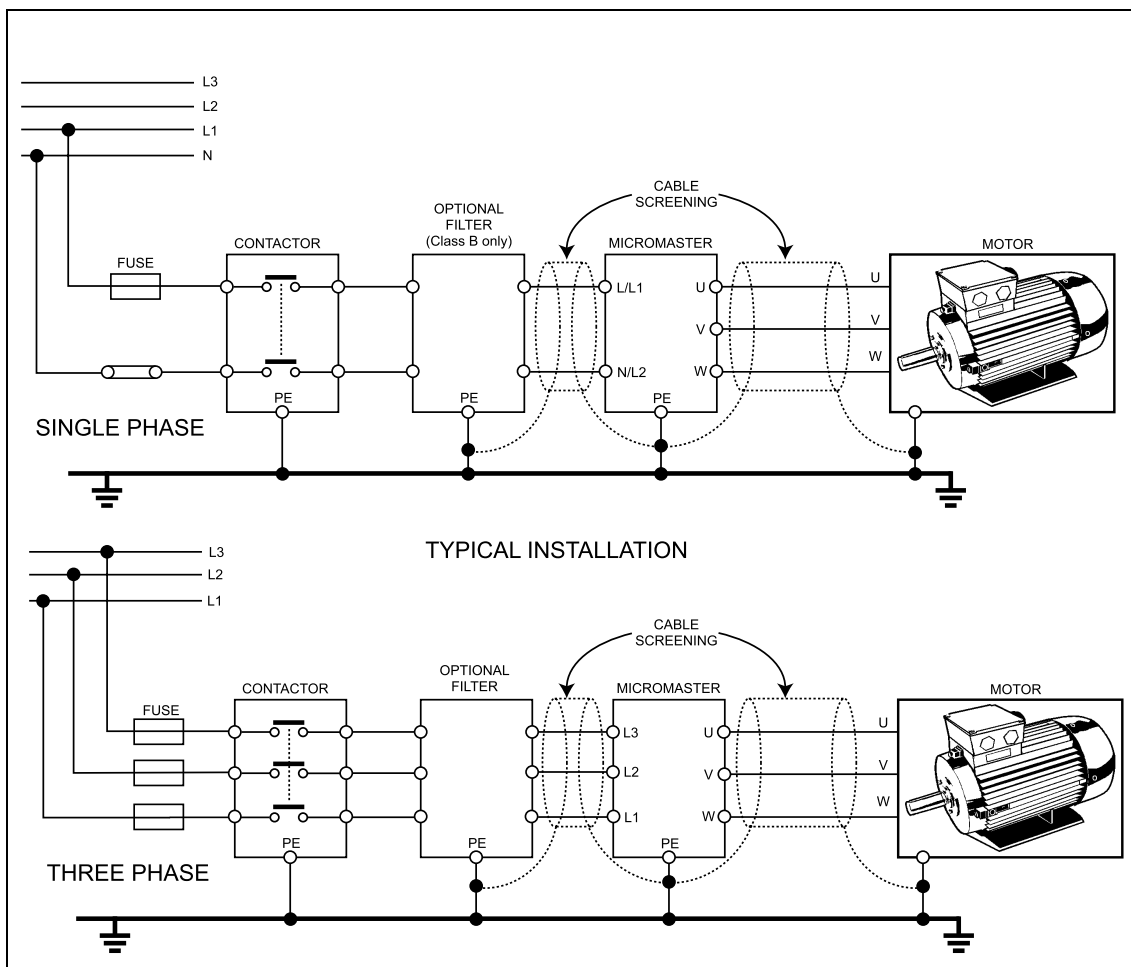

Figure 2-6 Motor and Power Connections

2.4.3 Avoiding Electro-Magnetic Interference (EMI)

The inverters are designed to operate in an industrial environment where a high level of EMI can be expected. Usually, good installation practices will ensure safe and trouble-free operation. If you encounter problems, follow the guidelines stated below.

Action to Take

- Ensure that all equipment in the cubicle is well grounded using short, thick grounding cable connected to a common star point or busbar.
- Make sure that any control equipment (such as a PLC) connected to the inverter is connected to the same ground or star point as the inverter via a short thick link.
- Connect the return ground from the motors controlled by the inverters directly to the ground connection (PE) on the associated inverter.
- Flat conductors are preferred as they have lower impedance at higher frequencies.
- Terminate the ends of the cable neatly, ensuring that unscreened wires are as short as possible.
- **Separate the control cables from the power cables as much as possible, using separate trunking, if necessary at 90° to each other.**
- Whenever possible, use screened leads for the connections to the control circuitry.
- Ensure that the contactors in the cubicle are suppressed, either with R-C suppressors for AC contactors or 'flywheel' diodes for DC contactors fitted to the coils. Varistor suppressors are also effective. This is important when the contactors are controlled from the inverter relay.
- Use screened or armored cables for the motor connections and ground the screen at both ends using the cable clamps.



WARNING

Safety regulations **must not** be compromised when installing inverters!

2.4.4 Screening Methods

Frame Size C

For frame size C the Gland Plate Kit is supplied as an option. It allows easy and efficient connection of the necessary screening. See the Gland Plate Installation Instructions contained on the Document CD-ROM, supplied with the MM430.

Frame Sizes D, E and F

The Gland Plate is factory fitted. The installation of the screening is accomplished using the same methodology as in frame size C.

Screening without a Gland Plate

Should a Gland Plate not be available, then the inverter can be screened using the methodology shown in Figure 2-7.

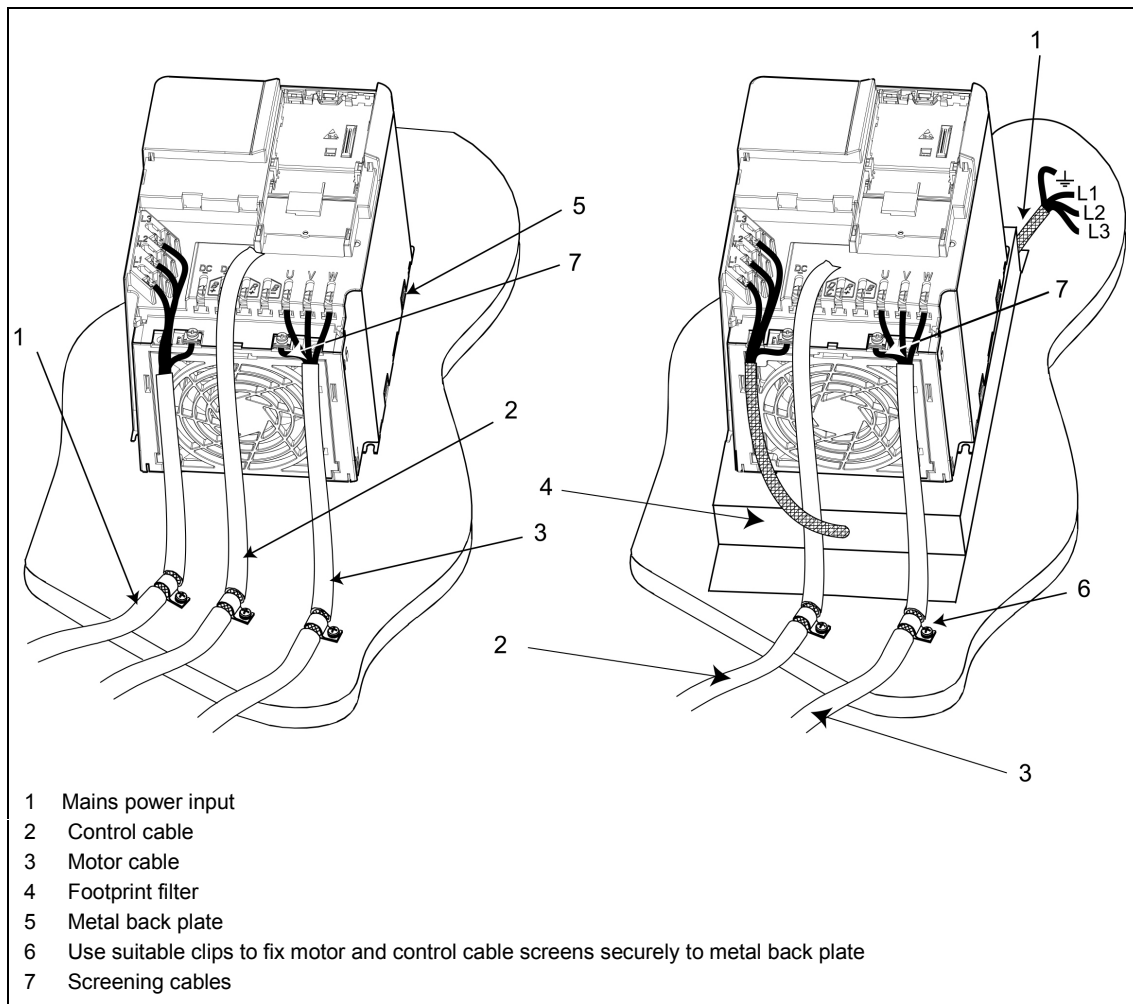

Figure 2-7 Wiring Guidelines to Minimize the Effects of EMI

3 Commissioning

This Chapter contains:

- A schematic diagram of the MICROMASTER 430
- An overview of the commissioning options and the display and operator panels
- An overview of quick commissioning of the MICROMASTER 430

3.1	Block diagram.....	33
3.2	Commission modes.....	34
3.3	General operation.....	45



WARNING

- ◆ MICROMASTERS operate at high voltages.
 - ◆ When operating electrical devices, it is impossible to avoid applying hazardous voltages to certain parts of the equipment.
 - ◆ Emergency Stop facilities according to EN 60204 IEC 204 (VDE 0113) must remain operative in all operating modes of the control equipment. Any disengagement of the Emergency Stop facility must not lead to uncontrolled or undefined restart.
 - ◆ Wherever faults occurring in the control equipment can lead to substantial material damage or even grievous bodily injury (i.e. potentially dangerous faults), additional external precautions must be taken or facilities provided to ensure or enforce safe operation, even when a fault occurs (e.g. independent limit switches, mechanical interlocks, etc.).
 - ◆ Certain parameter settings may cause the inverter to restart automatically after an input power failure.
 - ◆ Motor parameters must be accurately configured for motor overload protection to operate correctly.
 - ◆ This equipment is capable of providing internal motor overload protection in accordance with UL508C section 42. Refer to P0610 and P0335, i^2t is ON by default. Motor overload protection can also be provided using an external PTC (disabled by default P0601).
 - ◆ This equipment is suitable for use in a circuit capable of delivering not more than 10,000 symmetrical amperes (rms), for a maximum voltage of 460V when protected by a H or K type fuse (see *Tables starting on page 87*).
 - ◆ This equipment must not be used as an 'emergency stop mechanism' (see *EN 60204, 9.2.5.4*)
-



CAUTION

Only qualified personnel may enter settings in the control panels. Particular attention must be paid to safety precautions and warnings at all times.

3.1 Block diagram

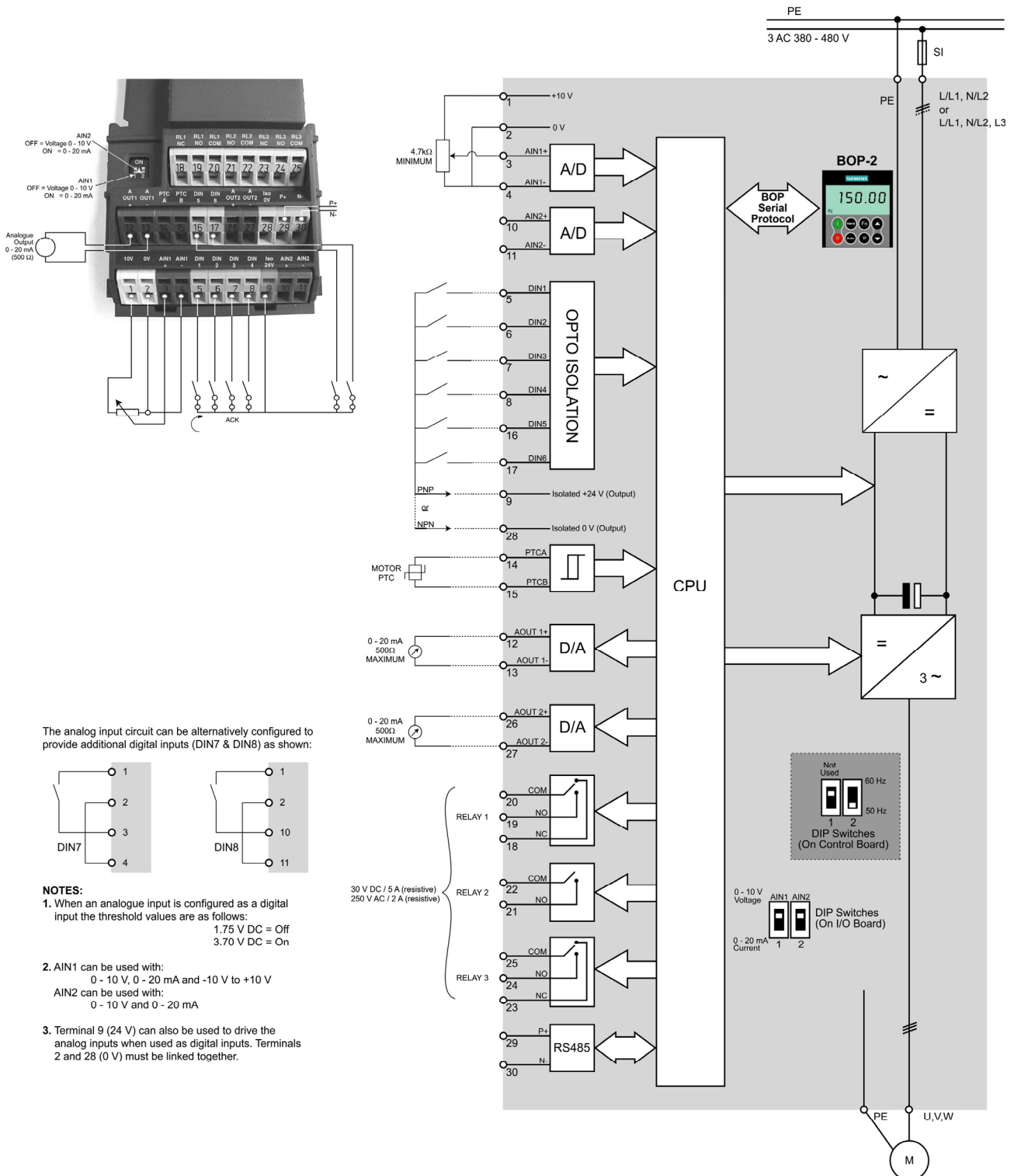

Figure 3-1 Inverter block diagram

3.2 Commission modes

In the standard version, the MICROMASTER 430 is fitted with the Status Display Panel (SDP) (see Figure 3-2) with which it is possible to use the inverter with the pre-assigned factory settings for a large range of applications. If these factory settings are not suitable, you can adapt them to suit your equipment conditions using the Basic Operator Panel-2 (BOP-2) (see Figure 3-2). The BOP-2 are available as options. You can also adjust the factory settings using the PC IBN tool. This software is available on the CD ROM which comes with the documentation of the unit.

ATTENTION

MICROMASTER 430 can only be operated with the BOP-2.
It is not possible to use BOP or AOP.

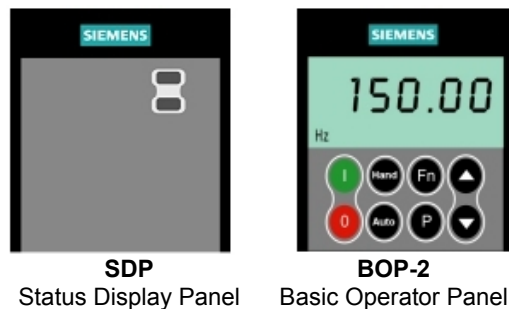

Figure 3-2 Panels available for the MICROMASTER 430 Inverter

For notes on replacing the operator panels please refer to the corresponding annexes A to this manual.

NOTICE

Frequency setting; the DIP switch is located on the control board, underneath the I/O board as shown in Figure 3-3 below. The inverter is delivered as follows:

- DIP switch 2:
 - ◆ Off position: European defaults (50 Hz, kW etc.)
 - ◆ On position: North American defaults (60 Hz, hp etc.)
- DIP switch 1: Not for customer use.

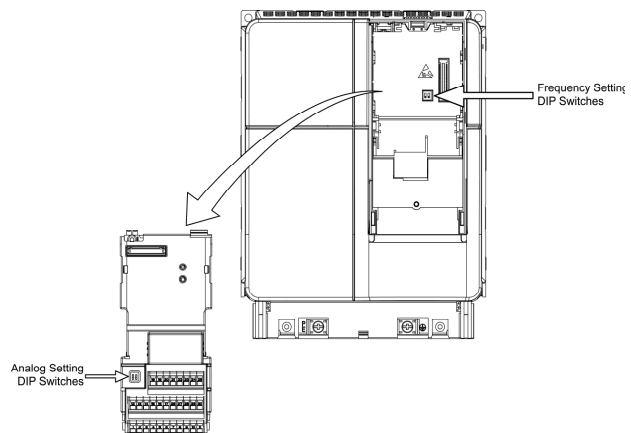
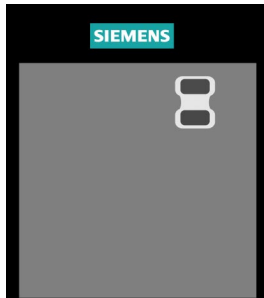

Figure 3-3 DIP switch

3.2.1 Commissioning with the SDP



The SDP has two LEDs on the front which display the current operating status of the inverter (see Section 6.1).

When the SDP is used, the presettings of the inverter must be compatible with the following motor data:

- Rated motor power
- Motor voltage
- Rated motor current
- Rated motor frequency

(A conventional Siemens motor is recommended)

In addition, the following conditions must be met:

- Linear V/f motor speed controlled by an analog potentiometer.
- Maximum speed 3000 rpm at 50 Hz (3600 rpm at 60 Hz); can be controlled by a potentiometer via the analog inputs of the inverter.
- Ramp-up time = 10 s
- Ramp-down time = 30 s

Settings for more complex applications can be found in the parameter list and in Section 3.2.2 "Commission Overview with BOP-2".

Table 3-1 Default settings for operation using the SDP

	Terminals	Parameter	Default Operation
Digital Input 1	5	P0701 = '1'	ON right
Digital Input 2 *	6	P0702 = '12'	Reverse
Digital Input 3	7	P0703 = '9'	Fault Acknowledge
Digital Input 4	8	P0704 = '15'	Fixed Frequency
Digital Input 5	16	P0705 = '15'	Fixed Frequency
Digital Input 6	17	P0706 = '15'	Fixed Frequency
Digital Input 7	Via AIN1	P0707 = '0'	Inactive
Digital Input 8	Via AIN2	P0708 = '0'	Inactive

* The standard setting for the change of rotation direction is as inhibited. (Parameter 1110)

Basic operation with SDP

With the SDP fitted, the following is possible:

- Start and stopping the motor (DIN1 via external switch)
- Fault Reset (DIN3 via external switch)

Controlling the speed of the motor is accomplished by connecting the analog inputs as shown in the Figure 3-4.

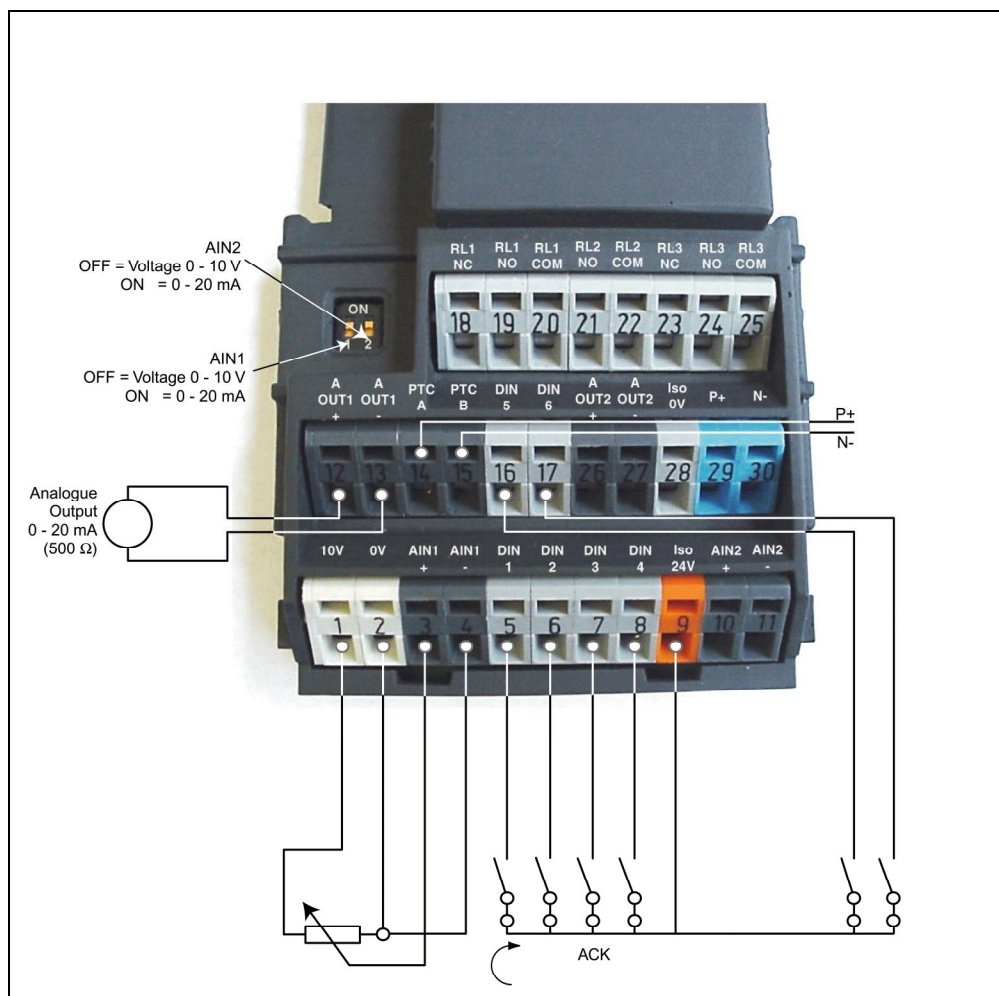
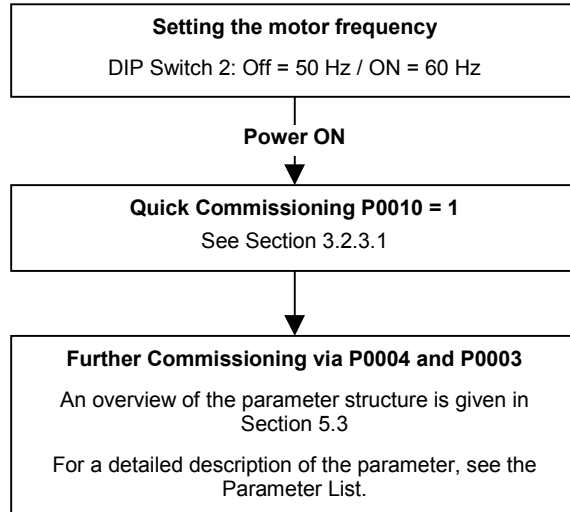

Figure 3-4 Basic operation with SDP

3.2.2 Commission Overview with BOP-2

Prerequisites

Mechanical and electrical Installation are completed.



NOTES

We recommend the commissioning according this scheme.

3.2.2.1 Commissioning with the BOP-2

You can alter parameter values via the BOP-2. To set parameters on this panel, you must remove the SDP and attach the BOP-2 (see Appendix A).



The BOP-2 features a five-digit, seven-segment display for showing parameter numbers and values, alarm and fault messages and setpoints and actual values. Parameter sets cannot be saved via the BOP-2.

Table 3-2 shows the factory default settings for operation via the BOP-2.

NOTICE

- ◆ The BOP-2 motor control functions are disabled by default. To control the motor via the BOP-2, parameter P0700 should be set to 1 and P1000 set to 1.
- ◆ The BOP-2 can be fitted to and removed from the inverter whilst power is applied.
- ◆ If the BOP-2 has been set as the I/O control (P0700 = 1), the drive will stop if the BOP-2 is removed.

Table 3-2 Default settings for operation using the BOP-2

Parameter	Meaning	Default Europe (North America)
P0100	Operating Mode Europe/US	50 Hz, kW (60 Hz, hp)
P0307	Power (rated motor)	Dimension (kW (Hp)) depending on setting of P0100. [Value depending on variant.]
P0310	Motor frequency rating	50 Hz (60 Hz)
P0311	Motor speed rating	1395 (1680) rpm [depending on variant]
P1082	Maximum Motor Frequency	50 Hz (60 Hz)

ATTENTION

MICROMASTER 430 can only be operated using a BOP-2 bedient werden. If a BOP or AOP is used, the following is shown on the display -----.

Buttons on the BOP-2

















Panel/Button	Function	Effects
	Indicates Status	The LCD displays the settings currently used by the converter.
	Start motor	Pressing the button starts the converter. This button is disabled by default. To enable this button set P0700 = 1.
	Stop motor	OFF1 Pressing the button causes the motor to come to a standstill at the selected ramp down rate. Disabled by default; to enable set P0700 = 1. OFF2 Pressing the button twice (or once long) causes the motor to coast to a standstill. This function is always enabled.
	Manual mode	The customer terminal strip (CD S0) and the operating panel (BOP-2) are sources for commands and set values
	Automatic mode	The customer's terminal strip (CD S1) or the serial (US S) or field bus interface (e.g. PROFIBUS) are sources for commands and set values.
	Functions	This button can be used to view additional information. Pressing and holding the button for 2 seconds from any parameter during operation, shows the following: 1. DC link voltage (indicated by d – units V). 2. Output current. (A) 3. Output frequency (Hz) 4. Output voltage (indicated by o – units V). 5. The value selected in P0005 (If P0005 is set to show any of the above (3, 4, or 5) then this will not be shown again). Additional presses will toggle around the above displays. Jump Function From any parameter (rXXXX or PXXXX) a short press of the Fn button will immediately jump to r0000, you can then change another parameter, if required. Upon returning to r0000, pressing the Fn button will return you to your starting point. Quit In case of a fault or alarm the  button resets the fault or alarm message on the operator panel display.
	Access parameters	Pressing this button allows access to the parameters.
	Increase value	Pressing this button increases the displayed value.
	Decrease value	Pressing this button decreases the displayed value.

Figure 3-5 Buttons on the BOP-2

Changing parameters with the BOP-2

The procedure for changing the value of parameter P0004 is described below. Modifying the value of an indexed parameter is illustrated using the example of P0719. Follow exactly the same procedure to alter other parameters that you wish to set via the BOP-2.

Changing P0004 – parameter filter function

Step	Result on display
1 Press  to access parameters	r 0000
2 Press  until P0004 is displayed	P0004
3 Press  to access the parameter value level	0
4 Press  or  to the required value	7
5 Press  to confirm and store the value	P0004
6 Only the command parameters are visible to the user.	

Changing P0719 an indexed parameter Selection of command/setpoint source









Step	Result on display
1 Press  to access parameters	r 0000
2 Press  until P0719 is displayed	P0719
3 Press  to access the parameter value level	r 0000
4 Press  to display current set value	0
5 Press  or  to the required value	12
6 Press  to confirm and store the value	P0719
7 Press  until r0000 is displayed	r 0000
8 Press  to return the display to the standard drive display (as defined by the customer)	

Figure 3-6 Changing parameters via the BOP-2





NOTES

In some cases - when changing parameter values - the display on the BOP-2 shows **buSY**. This means the inverter is busy with tasks of higher priority.

Changing single digits in Parameter values

For changing the parameter value rapidly, the single digits of the display can be changed by performing the following actions:

Ensure you are in the parameter value changing level (see "Changing parameters with BOP-2").

1. Press  (function button), which causes the right hand digit to blink.
2. Change the value of this digit by pressing  / .
3. Press  (function button) again causes the next digit to blink.
4. Perform steps 2 to 4 until the required value is displayed.
5. Press the  to leave the parameter value changing level.

NOTES

The function button may also be used to acknowledge a fault condition

3.2.3 Commissioning functions with BOP-2**3.2.3.1 Quick commissioning (P0010=1)**

Mechanical and electrical installation of the inverter must be completed before running „Quick Commissioning“.

It is **important** that parameter P0010 is used for commissioning and P0003 is used to select the access level.

There are three user levels, standard, extended and expert. The lower the access level fewer parameters can be seen while performing Quick commissioning. The values for these parameters are either the default settings or are calculated during quick commissioning.

Quick commissioning includes motor and ramp setting parameters.

Quick Commissioning concludes with P3900, which, when set to 1, will perform the necessary motor calculations and clear all other parameters (not included in P0010=1) to the default settings. After completing Quick Commissioning with P3900 = 1, the inverter is then ready to run; this will only happen in the Quick Commissioning mode.

Flow chart Quick Commissioning

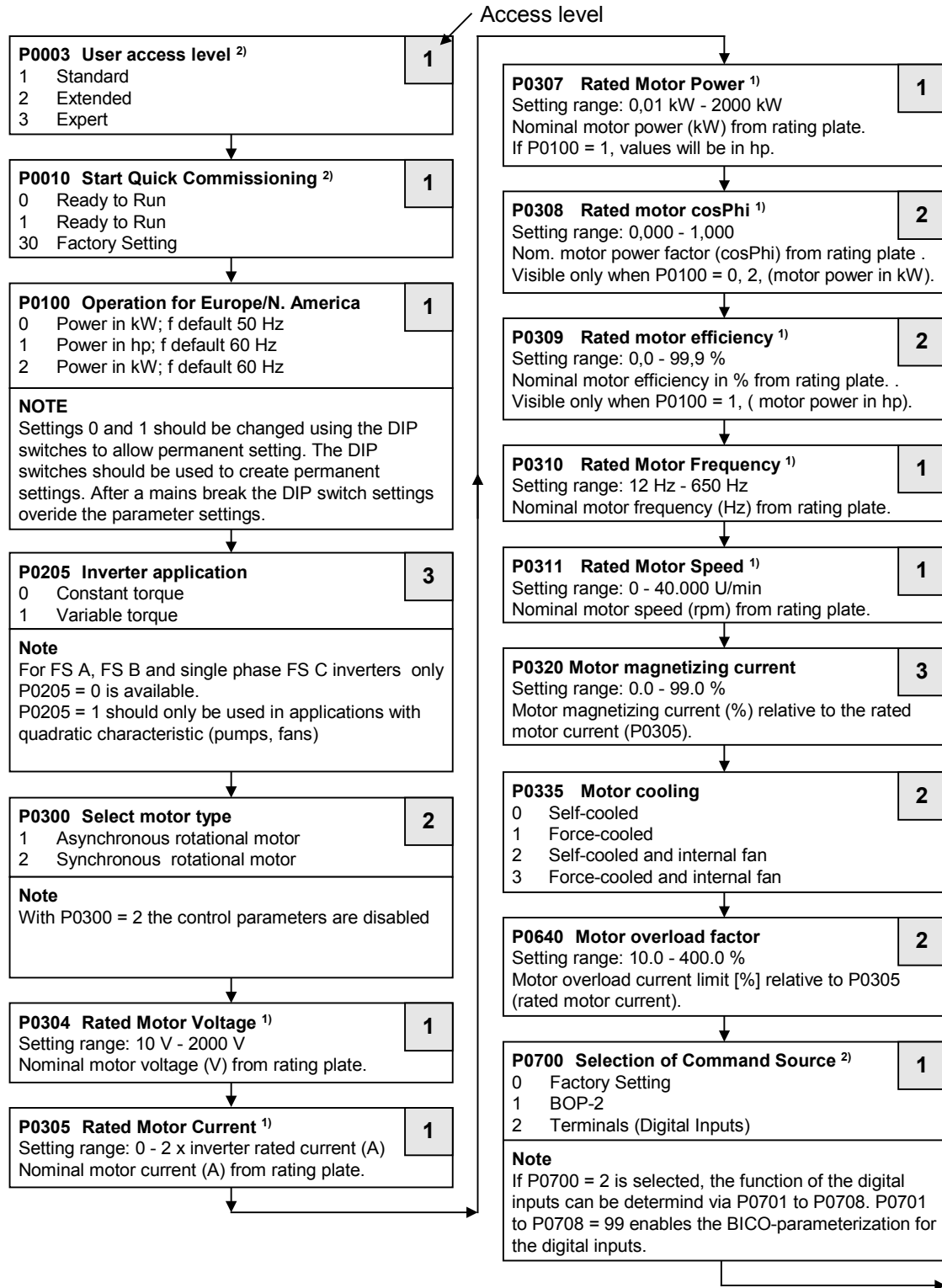

1) Motor-specific parameters – see motor rating plate.
 2) The parameters offer more setting options than listed here. See Parameter List for further setting options.

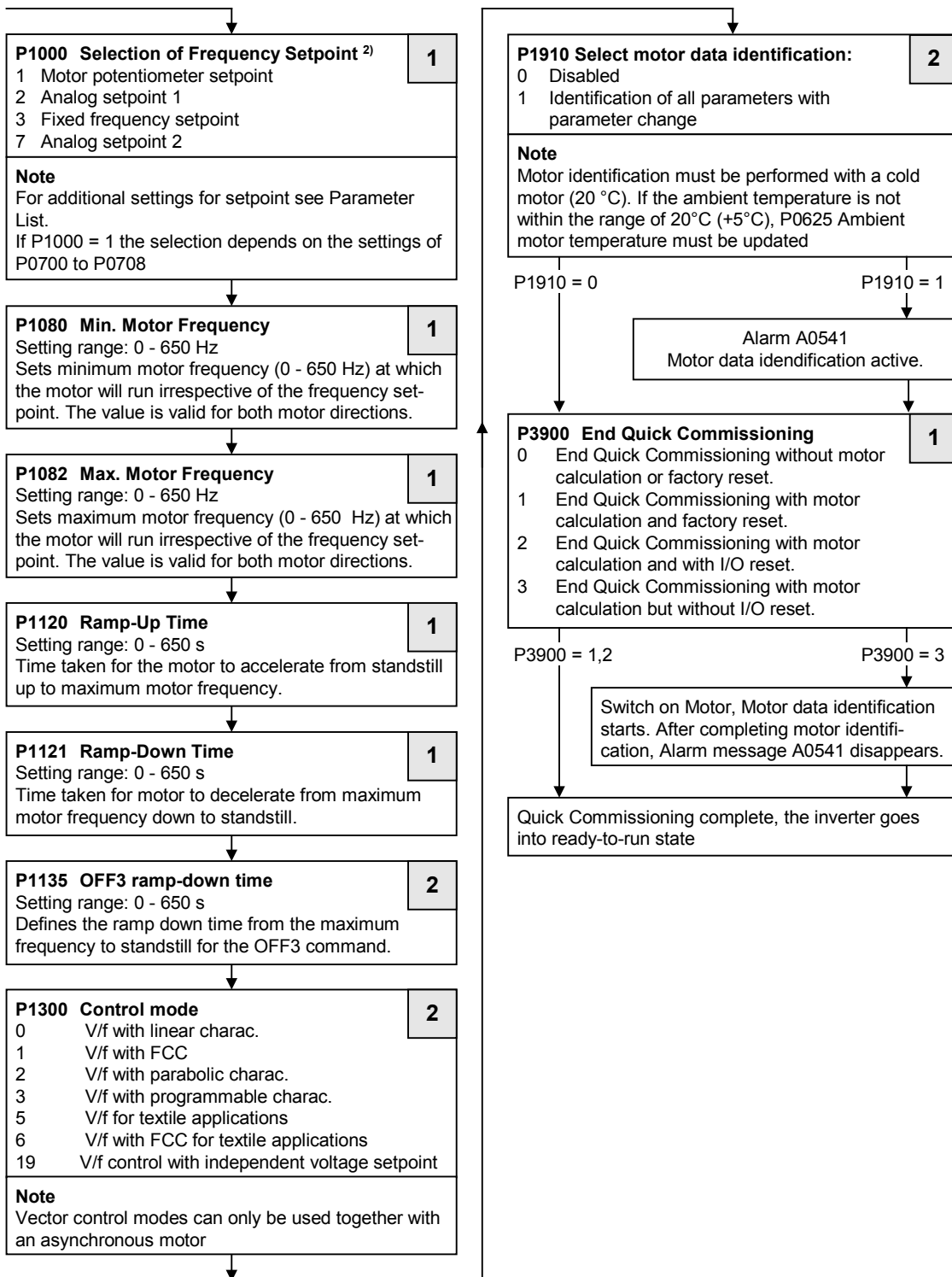

2) The parameters offer more setting options than listed here. See Parameter List for further setting options.

Motor data for parameterization

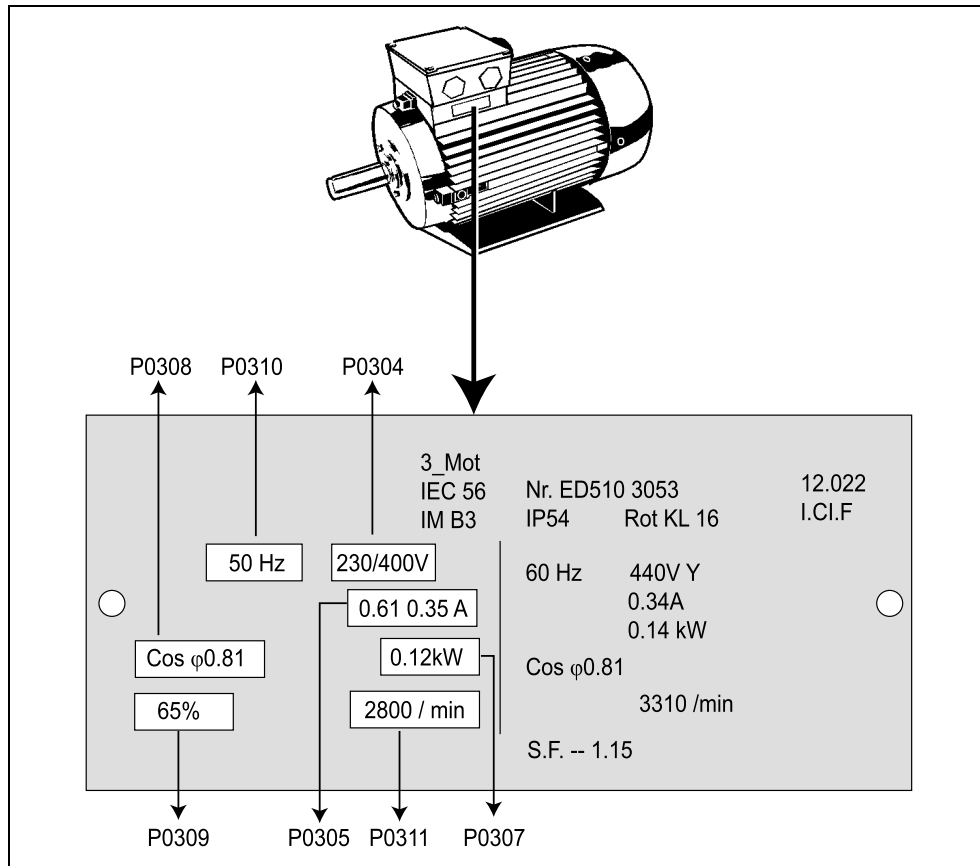

Figure 3-7 Typical Motor Rating Plate Example

NOTICE

- P0308 & P0309 are only visible if P0003 \geq 2. Only one of the parameters is shown depending on the settings of P0100.
- P0307 indicates kW or HP depending upon the setting of P0100. For detailed information, please see the Parameter List.
- Changing motor parameters is not possible unless P0010=1.
- Ensure that the inverter is configured correctly to the motor.

3.2.4 Reset to Factory default

To reset all parameters to the factory default settings; the following parameters should be set as follows (BOP-2 or Communication Option needed):

1. Set P0010=30.
2. Set P0970=1.

NOTE

The reset process can take up to 3 minutes to complete.

3.3 General operation

For a full description of standard and extended parameters, please refer to the Parameter List.







NOTICE

1. The inverter does not have a main power switch and is live when the mains supply is connected. It waits, with the output disabled, until the RUN button is pressed or for the presence of a digital ON signal at terminal 5 (rotate right).
 2. If a BOP-2 is fitted and the output frequency is selected to be displayed (P0005 = 21) the corresponding setpoint is displayed approximately every 1.0 seconds while the inverter is stopped.
 3. The inverter is programmed at the factory for standard applications on Siemens four-pole standard motors that have the same power rating as the inverters. When using other motors it is necessary to enter the specifications from the motor's rating plate. See Figure 3-7 for details on how to read motor data.
 4. Changing motor parameters is not possible unless P0010 = 1.
 5. You must set P0010 back to 0 in order to initiate a run.
-

Basic operation with the BOP-2

Prerequisites

- P0010 = 0 (in order to initiate the run command correctly).
 - P0700 = 1 (enables the start/stop button on the BOP-2).
 - P1000 = 1 (this enables the motor potentiometer setpoints).
-

1. Press the green Button  to start the motor.
 2. Press the Button  while the motor is turning. Motor speed increases to 50 Hz.
 3. When the inverter reaches 50 Hz, press the Button . Motor speed and display is decreased.
 4. Press button , to activate manual mode.
 5. Press button , to activate automatic mode.
 6. The red button stops the motor .
-

Note

Three Command data sets (CDS) are available. The Hand/Auto-Button on the BOP-2 toggles between CDS 1 and CDS 2. If CDS 3 is selected (via P0811), the Hand/Auto-Button on the BOP-2 is inactive. For further details see the Parameter List

External motor thermal overload protection

When operated below rated speed, the cooling effect of fans fitted to the motor shaft is reduced. Consequentially, most motors require de-rating for continuous operation at low frequencies. To ensure that the motors are protected against overheating under these conditions, a PTC temperature sensor must be fitted to the motor and connected to the inverter control terminals. P0601 must also be set to 1.

If the PTC in the motor is connected to the MICROMASTER 440 control terminals 14 and 15 and the PTC function enabled by setting P0601 = 1, then the MICROMASTER 440 will operate as normal providing the resistance at the terminals remains below approximately 1500 Ω . If this value is exceeded, the inverter indicates a warning A0510 and then a fault. The actual resistance value at which this occurs will not be less than 1000 Ω , and not more than 2000 Ω .

With KTY84 sensor

The KTY84 has to be connected so that the diode is forward biased; that is the anode is connected to PTC A (+) and the cathode to PTC B (-).

If the temperature monitoring function is enabled by setting P0601 = 2, the temperature of the sensor (and therefore the motor windings) is written to parameter r0035. The threshold motor temperature can now be set using parameter P0604 (default setting 130 °C).

Connection failure

If the connection to the PTC or KTY84 sensor becomes open circuit or short circuit, a fault will be indicated, and by default the drive will trip.

NOTE

To enable the trip function, set parameter P0701, P0702 or P0703 = 29.

4 MICROMASTER 430 functions

This chapter contains:

- a description of the different procedures to control the inverter
- a summary of the control types of the inverter.

4.1	Frequency set point (P1000).....	48
4.2	Command sources (P0700).....	49
4.3	OFF and brake function	49
4.4	Control modes (P1300).....	51
4.5	MICROMASTER 430	52
4.6	Faults and Alarms	56

**WARNING**

- ◆ When operating electrical devices, certain parts of these devices are always live.
- ◆ Emergency Off devices in compliance with EN 60204 IEC 204 (VDE 0113) must remain functional in all operating modes of the control device. Resetting the Emergency Off device must not result in uncontrolled or undefined re-starts.
- ◆ In those cases, where short circuits in the control device can result in considerable material damage or even serious bodily harm (i.e. potentially dangerous short circuits), external measures or devices must be taken or fitted to ensure that operation is not dangerous even if a short circuit does occur (e.g. independent limit switches, mechanical locks etc.).
- ◆ MICROMASTER inverters work with high voltages.
- ◆ Certain parameter settings can cause the inverter to start up again automatically after the supply voltage has failed.
- ◆ The motor parameters must be configured exactly to ensure perfect motor overload protection.
- ◆ The device provides an internal motor overload protection system in compliance with UL508C, section 42. See P0610 and P0335, the pre-setting for i^2t is ON. Motor overload protection can also be secured via an external OTC (factory setting: P0601 "Motor-temperature sensor" deactivated) .
- ◆ The device is suitable for use with circuits which supply a symmetrical current of a maximum of 10.000 A (eff) with a maximum voltage of 460 V, if it is protected by a fuse of Type H or K (see table Table 7-3 onwards).
- ◆ This device must not be used as an „Emergency Off device“ (see EN 60204, 9.2.5.4).

4.1 Frequency set point (P1000)

- Pre-setting: terminal 3/4 (AIN+/ AIN -, 0...10 V equivates to 0...50/60 Hz)
- Additional settings: see P1000

NOTE

With regard to USS see reference manual, with regard to PROFIBUS see reference manual and PROFIBUS instructions.

4.2 Command sources (P0700)

ATTENTION

The **ramp-up /ramp-down times** and **ramp smoothing** also have an effect on the motor's start and stop behaviour. Further details about these functions are to be found in the parameter list for parameters P1120, P1121, P1130 – P1134.

Start motor

- Default: terminal 5 (DIN1, high)
- Additional settings: see P0700 to P0708

Stop motor

- There are a number of possibilities to stop the motor:
- Default :
 - ◆ OFF1 terminal 5 (DIN1, low)
 - ◆ OFF2 OFF key on BOP-2, press the OFF key once for 2 seconds or press twice
 - ◆ OFF3 not active in factory settings
- Additional settings: see P0700 to P0708

Reversing the direction of rotation of the motor

This function is inhibited in the factory settings. To release it, you must set P1110 = 0.

- Default: terminal 6 (DIN2, high)
- Additional settings: see P0700 to P0708

4.3 OFF and brake function

4.3.1 OFF1

This command (which is triggered by the cancellation of the ON order) causes the inverter to come to a standstill within the selected ramp-down time.

For parameters to change ramp-down time: see P1121

ATTENTION

- The ON and the subsequent OFF command must come from the same source.
 - If the ON / OFF1 command is set for more than one digital input, only the digital input set last will be valid, e.g. DIN3 is active.
 - OFF1 can be combined with direct current or compound braking.
-

4.3.2 OFF2

This command causes the motor to run down freely to a standstill (impulses deactivated).

ATTENTION

The OFF command can have one or more sources. The default causes the OFF2 command to be set to BOP-2. This source continues to exist even if other sources are defined by **one** of the parameters P0700 to P0708.

4.3.3 OFF3

The OFF3 command causes the motor to be slowed down quickly.

The binary input must be closed to start the motor if the command OFF3 has been set. If OFF3 is closed, the motor can be started and stopped by commands OFF1 or OFF2.

If OFF3 is open, the motor cannot be started..

➤ ramp-down time: see P1135

ATTENTION:

OFF3 can be combined with DC braking, compound braking or dynamic braking.

4.3.4 DC braking

DC braking is possible together with OFF1 and OFF3. Direct current is input which brakes the motor quickly and holds the shaft until the end of the braking period.

- Activate DC braking: see P0701 to P0708
- Set DC brake period: see P1233
- Set DC braking current: see P1232
- Set DC braking start frequency: see P1234

ATTENTION

If no digital input is set to DC braking, DC braking is active for $P1233 \neq 0$ after every OFF1 command with the period set in P1233.

4.3.5 Compound braking

Compound braking is possible with OFF1 and OFF3. In the case of compound braking, a DC component is superimposed on the alternating current.

Set braking current : see P1236

4.4 Control modes (P1300)

MICROMASTER 430 has a number of different control modes based on U/f-control. The individual modes have been listed below, additional settings are listed in the parameter list and the function plans contained therein.

- **Linear U/f control** **P1300 = 0**
Can be used for variable and constant torque applications e.g. transport systems and positive displacement pumps.
- **Linear U/f control with flux current control (FCC)** **P1300 = 1**
This type of control can be used to improve the performance and dynamic behaviour of the motor.
- **Parabolic U/f control** **P1300 = 2**
This type of control can be used for variable torque loads e.g. fan and pumps.
- **Multiple point U/f control** **P1300 = 3**
Please refer to the MICROMASTER 430 parameter list for more information on this operating mode.
- **U/f control for textile applications** **P1300 = 5**
There is no slip compensation gain or resonance dampening. The I_{max} controller refers to voltage instead of frequency.
- **U/f control with FCC for textile applications** **P1300 = 6**
A combination of P1300 = 1 and P1300 = 5.
- **U/f control with independent voltage set point** **P1300 = 19**
Using the P1330, the voltage set point can be given independently from the starting frequency of the ramp function generator (HLG).

4.5 MICROMASTER 430 operating modes

4.5.1 Bypass Mode

Setting up an inverter bypass circuit

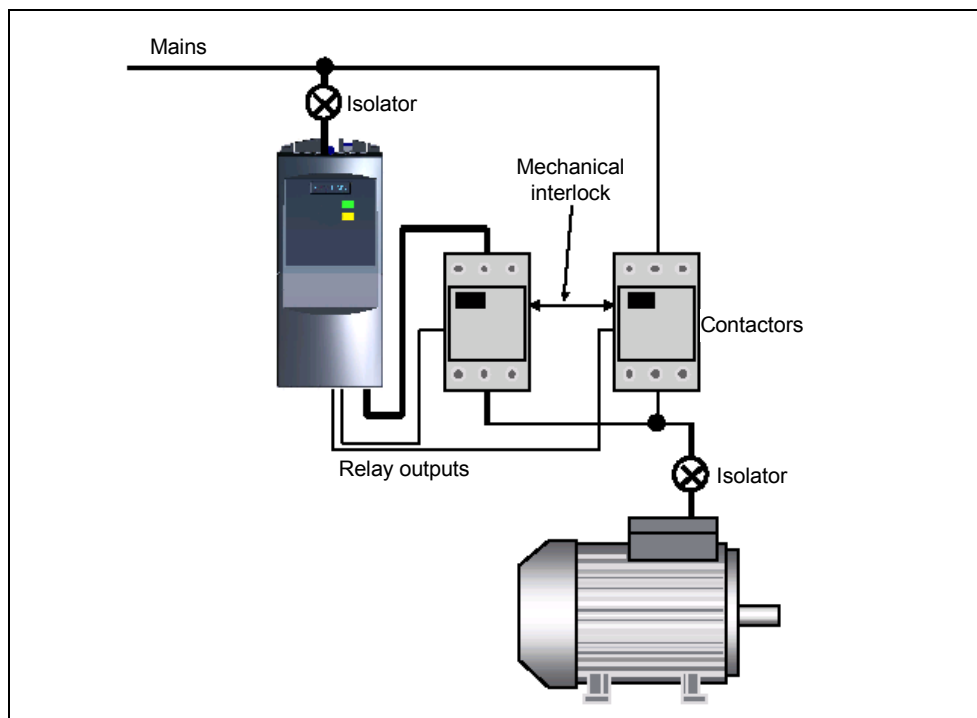

Figure 4-1 Bypass circuit

Function

Control of two locked contactors via relay outputs of MICROMASTER 430. This circuit makes it possible to operate the motor via the inverter or directly via the mains. The inverter is responsible for switching.

Switching is possible by the following means:

- error message from the inverter
- digital input
- inverter frequency

For further settings please refer to parameters list P1260 and following.

4.5.2 Belt Failure Detection

Recognizes mechanical faults in drive section e.g. torn V-belt, pumps which have run dry etc.

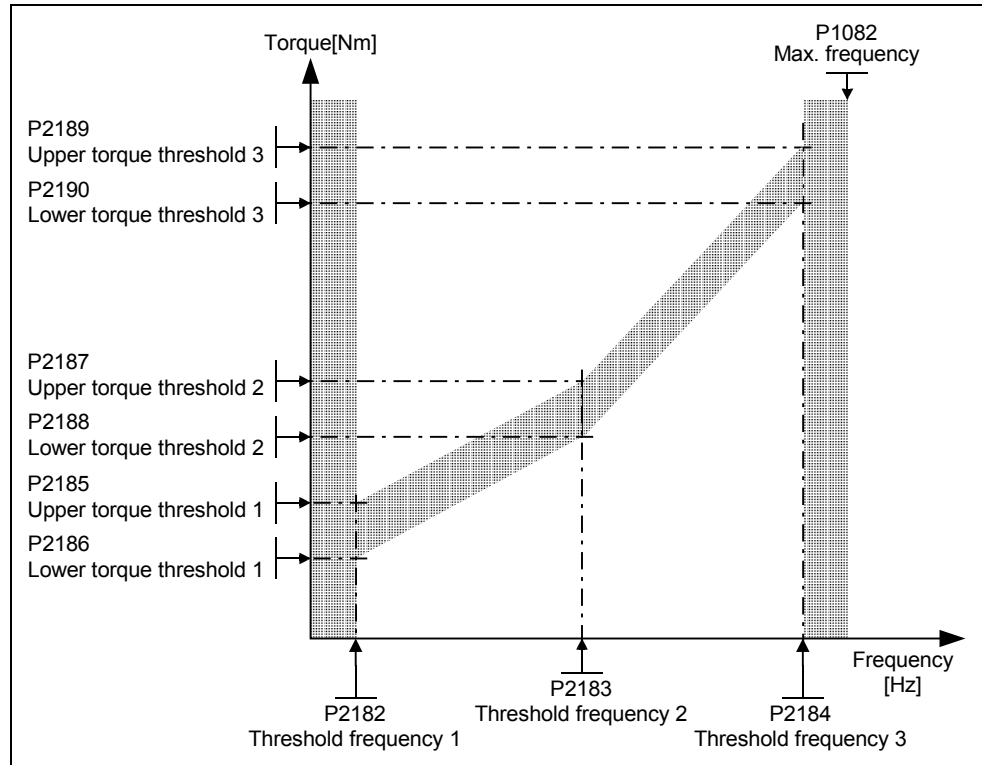

Figure 4-2 Belt Failure Detection

Function

A torque band is monitored. This enables underload and overload conditions to be recognized (e.g. ventilator not running correctly)

Comparison between current speed / torque curve with programmed envelope curve. The upper and lower frequency curve can be specified via three supporting points each. In addition a dead time until the function is triggered can be defined. This avoids accidental triggering due to transient events.

For additional settings please refer to parameter list P2181 and following.

4.5.3 Motor Staging

Controlling additional drives via output relay

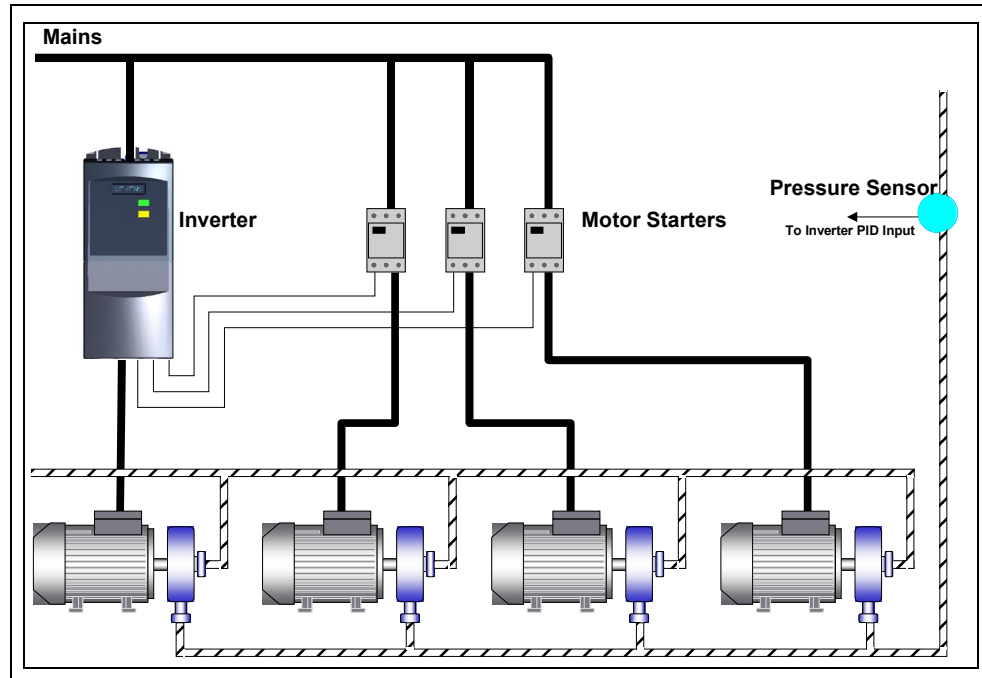

Figure 4-3 Motor Staging

Function

Enables up to three additional motors to be controlled based on PID control

The entire system is made up of a pump which is controlled by the inverter with up to an additional 3 pumps which can be added to the system via contactors or motor starters. The motor starter is controlled via the output relay in the inverter. Figure 4-3 shows a typical pump system.

This function can also be used accordingly for ventilators and ventilation shafts.

For additional settings please refer to parameter list P2370 and following.

4.5.4 Energy Saving Mode

Energy saving mode to switch off the motor when it is in idle mode

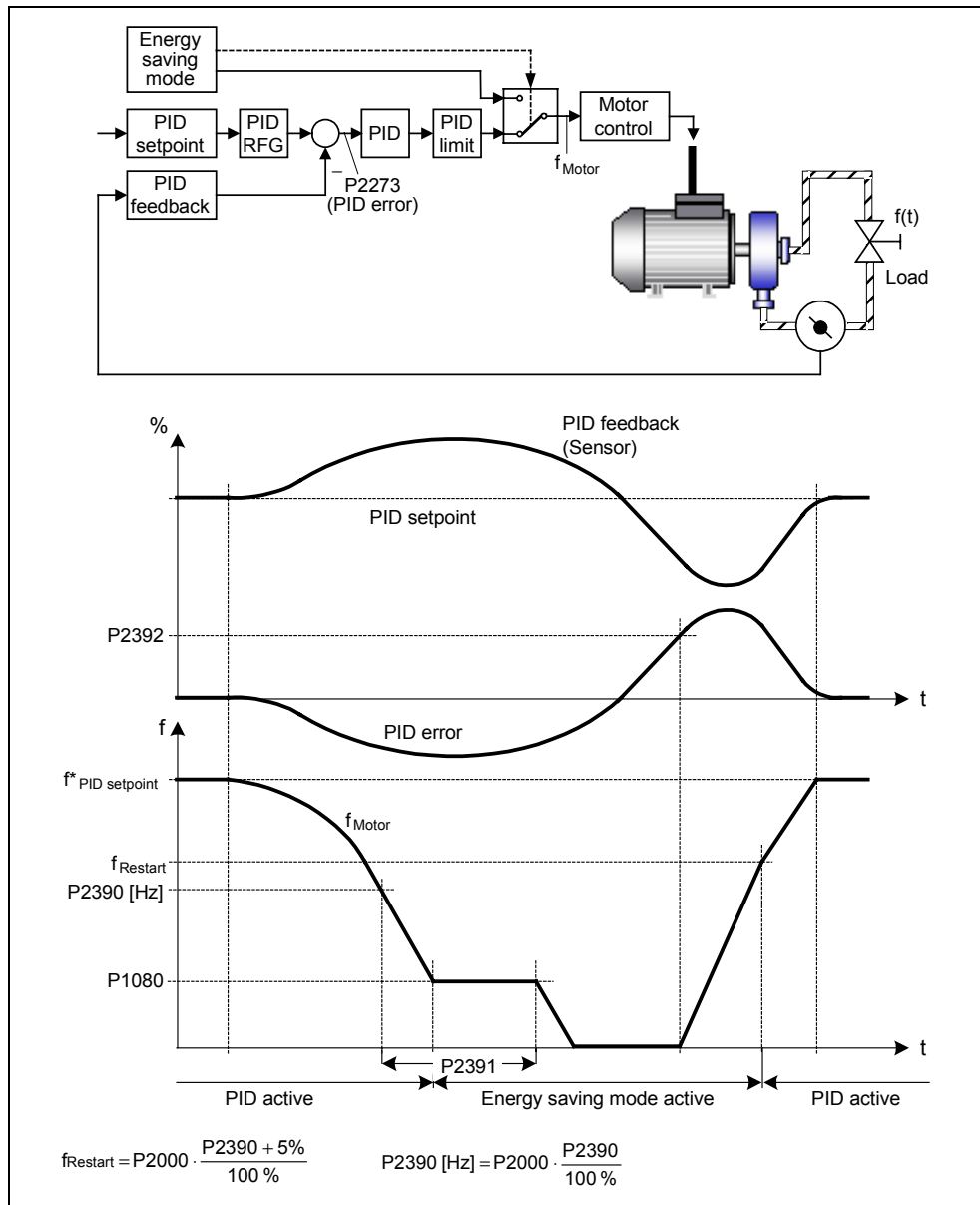

Figure 4-4 Energy Saving Mode

Function

Energy saving mode extends the function of the PID controller.

This enables the motor to be operated for a defined period of time with a minimum frequency and to switch it off afterwards. If the re-start frequency is reached, the motor is automatically re-started again. Energy saving mode is independent of the Motor Staging Function. It is possible to combine Motor Staging and Energy Saving Mode.

For additional settings please refer to the parameter list P2390 and following.

4.6 Faults and Alarms

SDP

With the SDP Faults and Alarms conditions are displayed via the two LEDs on the SDP. For further information see Section 6.1 on page 74

The operation status of the inverter is indicated by the two LEDs as follows:

- Green and yellow = Ready to run
- Green only = Inverter running
-

BOP-2

If a BOP-2 has been fitted to the inverter, details of any fault condition will be displayed by the operator panel. For detailed information of fault conditions and alarms, See Section 6 parameter list.

5 System parameters

This Chapter contains:

- An overview of the parameter structure of the MICROMASTER 430
- A parameter list in short form

5.1	Introduction to MICROMASTER system parameters.....	58
5.2	Parameter overview	59
5.3	Parameter list (short form)	60

5.1 Introduction to MICROMASTER system parameters

The parameters can only be changed by using the BOP-2 or the Serial Interface.

Parameters can be changed and set using the BOP-2 to adjust the desired properties of the inverter, such as ramp times, minimum and maximum frequencies etc. The parameter numbers selected and the setting of the parameter values are indicated on the optional five-digit LCD display.

- rxxxx indicates a display parameter, Pxxxx a setting parameter.
- P0010 initiates “quick commissioning”.
- The inverter will not run unless P0010 is set to 0 after it has been accessed. This function is automatically perform if P3900 > 0.
- P0004 acts as a filter, allowing access to parameters according to their functionality.
- If an attempt is made to change a parameter that cannot be changed in this status, for example, cannot be changed whilst running or can only be changed in quick commissioning, then `-----` will be displayed.
- **Busy Message**
In some cases - when changing parameter values - the display on the BOP-2 shows `buSY` for maximum of five seconds. This means the inverter is busy with tasks of higher priority.

ATTENTION

MICROMASTER 430 can only be operated using a BOP-2. If the BOP or AOP is used, the following is displayed `-----`.

5.1.1 Access Levels

There are three access levels available to the user; Standard, Extended and Expert. The level of access is set by parameter P0003. For most applications, Standard (P0003 = 1) or Extended parameters (P0003 = 2) are sufficient.

CAUTION

Some of level 4 parameters are for internal system settings only and should not be modified.

Level 4 parameters should only be modified by authorized personnel.

The number of parameters that appear within each functional group depends on the access level set in parameter P0003. For further details regarding parameters, see the Parameter List on the Documentation CD-ROM.

5.2 Parameter overview

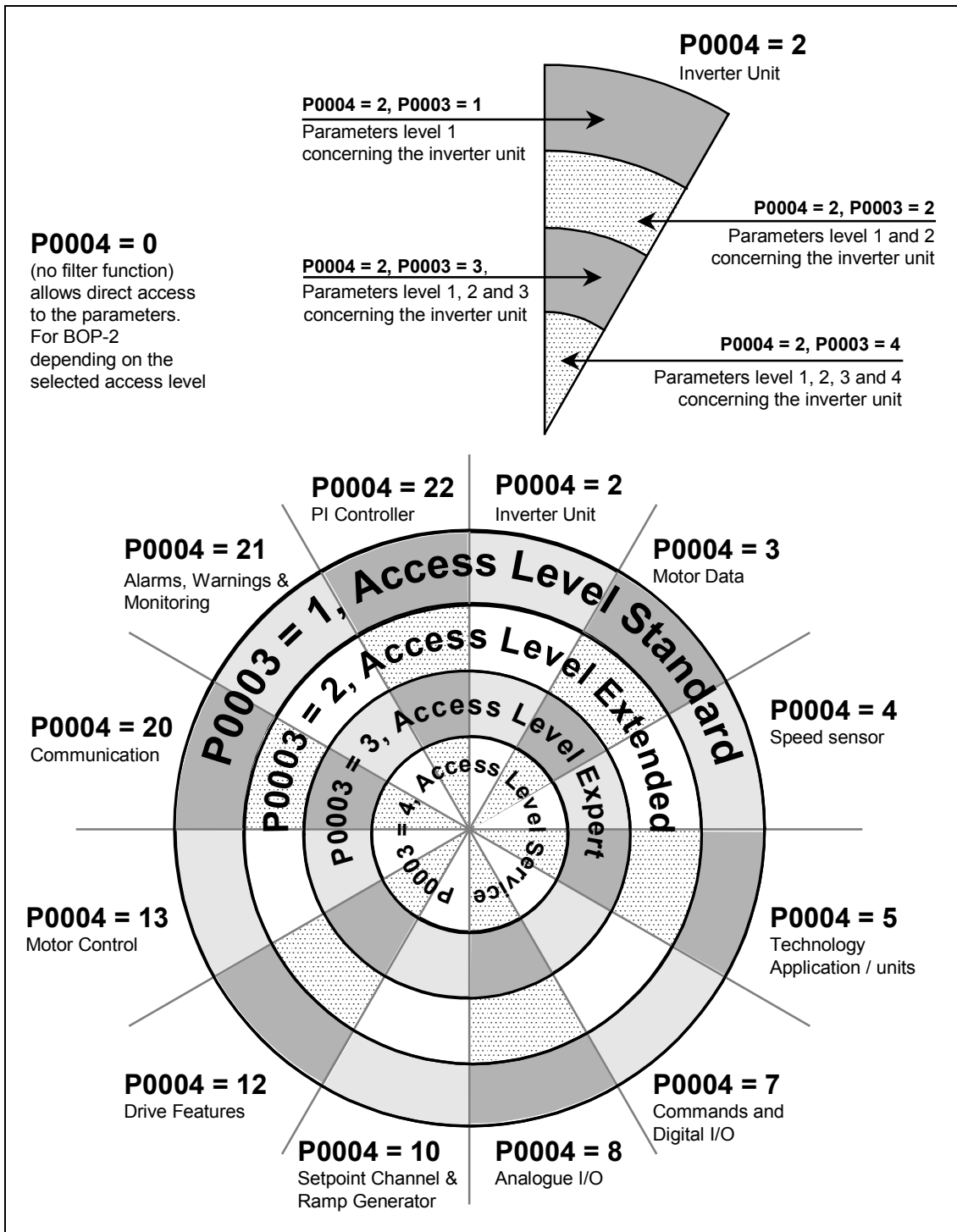

Figure 5-1 Parameter Overview

5.3 Parameter list (short form)

Explanatory information on following table:

- Default: Factory setting
- Level: Access level
- DS Inverter status (Drive State), indicates the inverter state in which a parameter can be modified (see P0010).
 - ◆ C Commissioning
 - ◆ U Run
 - ◆ T Ready to run
- QC Quick Commissioning
 - ◆ Q Parameter can be modified in the Quick Commissioning state.
 - ◆ N Parameter cannot be modified in the Quick Commissioning state.

Always

ParNr	ParText	Default	Level	DS	QC
r0000	Drive display	-	1	-	-
P0003	User access level	1	1	CUT	N
P0004	Parameter filter	0	1	CUT	N
P0010	Commissioning parameter	0	1	CT	N

Inverter Unit (P0004 = 2)

ParNr	ParText	Default	Level	DS	QC
P0100	Europe / North America	0	1	C	Q
P3900	End of quick commissioning	0	1	C	Q

Parameter Reset

ParNr	ParText	Default	Level	DS	QC
P0970	Factory reset	0	1	C	N

Inverter Unit (P0004 = 2)

ParNr	ParText	Default	Level	DS	QC
r0018	Firmware version	-	3	-	-
r0026[1]	CO: Act. DC-link voltage	-	3	-	-
r0037[2]	CO: Inverter temperature [°C]	-	3	-	-
r0039	CO: Energy consumpt. meter [kWh]	-	3	-	-
P0040	Reset energy consumption meter	0	3	CT	N
r0200	Act. power stack code number	-	3	-	-
P0201	Power stack code number	0	3	C	N
r0203	Act. inverter type	-	3	-	-
r0204	Power stack features	-	3	-	-
r0206	Rated inverter power [kW] / [hp]	-	3	-	-
r0207	Rated inverter current	-	3	-	-
r0208	Rated inverter voltage	-	3	-	-
r0209	Maximum inverter current	-	3	-	-

ParNr	ParText	Default	Level	DS	QC
P0210	Supply voltage	230	3	CT	N
r0231[2]	Max. cable length	-	3	-	-
P0290	Inverter overload reaction	2	3	CT	N
P0292	Inverter overload warning	15	3	CUT	N
P0291[3]	Inverter protection	1	3	CT	N
P1800	Pulse frequency	4	2	CUT	N
r1801	CO: Act. pulse frequency	-	3	-	-
P1802	Modulator mode	0	3	CUT	N
P1820[3]	Reverse output phase sequence	0	3	CT	N
P1911	No. of phase to be identified	3	3	CT	N
r1925	Identified on-state voltage	-	3	-	-
r1926	Ident. gating unit dead time	-	3	-	-

Motor Data (P0004 = 3)

ParNr	ParText	Default	Level	DS	QC
r0035[3]	CO: Act. motor temperature	-	3	-	-
P0304[3]	Rated motor voltage	230	1	C	Q
P0305[3]	Rated motor current	3.25	1	C	Q
P0307[3]	Rated motor power	0.75	1	C	Q
P0308[3]	Rated motor cosPhi	0.000	3	C	Q
P0309[3]	Rated motor efficiency	0.0	3	C	Q
P0310[3]	Rated motor frequency	50.00	1	C	Q
P0311[3]	Rated motor speed	0	1	C	Q
r0313[3]	Motor pole pairs	-	3	-	-
P0320[3]	Motor magnetizing current	0.0	3	CT	Q
r0330[3]	Rated motor slip	-	3	-	-
r0331[3]	Rated magnetization current	-	3	-	-
r0332[3]	Rated power factor	-	3	-	-
P0335[3]	Motor cooling	0	3	CT	Q
P0340[3]	Calculation of motor parameters	0	3	CT	N
P0344[3]	Motor weight	9.4	3	CUT	N
P0346[3]	Magnetization time	1.000	3	CUT	N
P0347[3]	Demagnetization time	1.000	3	CUT	N
P0350[3]	Stator resistance (line-to-line)	4.0	3	CUT	N
P0352[3]	Cable resistance	0.0	3	CUT	N
r0384[3]	Rotor time constant	-	3	-	-
r0395	CO: Total stator resistance [%]	-	3	-	-
r0396	CO: Act. rotor resistance	-	3	-	-
P0601[3]	Motor temperature sensor	0	3	CUT	N
P0604[3]	Threshold motor temperature	130.0	2	CUT	N
P0610[3]	Motor I2t temperature reaction	2	3	CT	N
P0625[3]	Ambient motor temperature	20.0	3	CUT	N
P0640[3]	Motor overload factor [%]	110.0	3	CUT	Q
P1910	Select motor data identification	0	3	CT	Q
r1912[3]	Identified stator resistance	-	3	-	-

Encoder (P0004 = 4)

ParNr	ParText	Default	Level	DS	QC
P0400[3]	Select encoder type	0	3	CT	N
P0408[3]	Encoder pulses per revolution	1024	3	CT	N
P0492[3]	Allowed speed difference	10.00	3	CT	N
P0494[3]	Delay speed loss reaction	10	3	CUT	N

Technological Functions (P0004 = 5)

ParNr	ParText	Default	Level	DS	QC
P0500[3]	Technological application	0	3	CT	Q

Commands and Digital I/O (P0004 = 7)

ParNr	ParText	Default	Level	DS	QC
r0002	Drive state	-	3	-	-
r0019	CO/BO: BOP control word	-	3	-	-
r0050	CO: Active command data set	-	2	-	-
r0052	CO/BO: Act. status word 1	-	3	-	-
r0051[2]	CO: Active drive data set (DDS)	-	2	-	-
r0053	CO/BO: Act. status word 2	-	3	-	-
r0054	CO/BO: Act. control word 1	-	3	-	-
r0055	CO/BO: Add. act. control word	-	3	-	-
r0403	CO/BO: Encoder status word	-	3	-	-
P0700[3]	Selection of command source	2	1	CT	Q
P0701[3]	Function of digital input 1	1	2	CT	N
P0702[3]	Function of digital input 2	12	2	CT	N
P0703[3]	Function of digital input 3	9	2	CT	N
P0704[3]	Function of digital input 4	15	2	CT	N
P0705[3]	Function of digital input 5	15	2	CT	N
P0706[3]	Function of digital input 6	15	2	CT	N
P0707[3]	Function of digital input 7	0	3	CT	N
P0708[3]	Function of digital input 8	0	3	CT	N
P0718	CO/BO: Hand / Auto	0	3	CUT	N
r0720	Number of digital inputs	-	3	-	-
P0719[3]	Selection of cmd. & freq. setp.	0	3	CT	N
r0722	CO/BO: Binary input values	-	3	-	-
P0724	Debounce time for digital inputs	3	3	CT	N
P0725	PNP / NPN digital inputs	1	3	CT	N
r0730	Number of digital outputs	-	3	-	-
P0731[3]	BI: Function of digital output 1	52:3	2	CUT	N
P0732[3]	BI: Function of digital output 2	52:7	2	CUT	N
P0733[3]	BI: Function of digital output 3	0:0	2	CUT	N
r0747	CO/BO: State of digital outputs	-	3	-	-
P0748	Invert digital outputs	0	3	CUT	N
P0800[3]	BI: Download parameter set 0	0:0	3	CT	N
P0801[3]	BI: Download parameter set 1	0:0	3	CT	N
P0810	BI: CDS bit 0 (Local / Remote)	718:0	3	CUT	N

ParNr	ParText	Default	Level	DS	QC
P0811	Bl: CDS bit 1	0:0	2	CUT	N
P0809[3]	Copy command data set (CDS)	0	3	CT	N
P0820	Bl: DDS bit 0	0:0	3	CT	N
P0821	Bl: DDS bit 1	0:0	3	CT	N
P0819[3]	Copy drive data set (DDS)	0	2	CT	N
P0840[3]	Bl: ON/OFF1	722:0	3	CT	N
P0842[3]	Bl: ON reverse/OFF1	0:0	3	CT	N
P0844[3]	Bl: 1. OFF2	1:0	3	CT	N
P0845[3]	Bl: 2. OFF2	19:1	3	CT	N
P0848[3]	Bl: 1. OFF3	1:0	3	CT	N
P0849[3]	Bl: 2. OFF3	1:0	3	CT	N
P0852[3]	Bl: Pulse enable	1:0	3	CT	N
P1020[3]	Bl: Fixed freq. selection Bit 0	0:0	3	CT	N
P1021[3]	Bl: Fixed freq. selection Bit 1	0:0	3	CT	N
P1022[3]	Bl: Fixed freq. selection Bit 2	0:0	3	CT	N
P1023[3]	Bl: Fixed freq. selection Bit 3	722:3	3	CT	N
P1026[3]	Bl: Fixed freq. selection Bit 4	722:4	3	CT	N
P1028[3]	Bl: Fixed freq. selection Bit 5	722:5	3	CT	N
P1035[3]	Bl: Enable MOP (UP-command)	19:13	3	CT	N
P1036[3]	Bl: Enable MOP (DOWN-command)	19:14	3	CT	N
P1074[3]	Bl: Disable additional setpoint	0:0	3	CUT	N
P1110[3]	Bl: Inhibit neg. freq. setpoint	1:0	3	CT	N
P1113[3]	Bl: Reverse	722:1	3	CT	N
P1140[3]	Bl: RFG enable	1:0	3	CT	N
P1141[3]	Bl: RFG start	1:0	3	CT	N
P1142[3]	Bl: RFG enable setpoint	1:0	3	CT	N
P1230[3]	Bl: Enable DC braking	0:0	3	CUT	N
P1270[3]	Bl: Enable essential service	0:0	3	CUT	N
P2103[3]	Bl: 1. Faults acknowledgement	722:2	3	CT	N
P2104[3]	Bl: 2. Faults acknowledgement	0:0	3	CT	N
P2106[3]	Bl: External fault	1:0	3	CT	N
P2220[3]	Bl: Fixed PID setp. select Bit 0	0:0	3	CT	N
P2221[3]	Bl: Fixed PID setp. select Bit 1	0:0	3	CT	N
P2222[3]	Bl: Fixed PID setp. select Bit 2	0:0	3	CT	N
P2223[3]	Bl: Fixed PID setp. select Bit 3	722:3	3	CT	N
P2226[3]	Bl: Fixed PID setp. select Bit 4	722:4	3	CT	N
P2228[3]	Bl: Fixed PID setp. select Bit 5	722:5	3	CT	N
P2235[3]	Bl: Enable PID-MOP (UP-cmd)	19:13	3	CT	N
P2236[3]	Bl: Enable PID-MOP (DOWN-cmd)	19:14	3	CT	N

Analogue I/O (P0004 = 8)

ParNr	ParText	Default	Level	DS	QC
P0295	Inverter fan off delay time	0	3	CUT	N
r0750	Number of ADCs	-	3	-	-
r0752[2]	Act. input of ADC [V] or [mA]	-	2	-	-

ParNr	ParText	Default	Level	DS	QC
P0753[2]	Smooth time ADC	3	3	CUT	N
r0754[2]	Act. ADC value after scaling [%]	-	2	-	-
r0755[2]	CO: Act. ADC after scal. [4000h]	-	3	-	-
P0756[2]	Type of ADC	0	2	CT	N
P0757[2]	Value x1 of ADC scaling [V / mA]	0	2	CUT	N
P0758[2]	Value y1 of ADC scaling	0.0	2	CUT	N
P0759[2]	Value x2 of ADC scaling [V / mA]	10	2	CUT	N
P0760[2]	Value y2 of ADC scaling	100.0	2	CUT	N
P0761[2]	Width of ADC deadband [V / mA]	0	3	UT	N
P0762[2]	Delay for loss of signal action	10	3	CUT	N
r0770	Number of DACs	-	3	-	-
P0771[2]	CI: DAC	21:0	2	CUT	N
P0773[2]	Smooth time DAC	2	3	CUT	N
r0774[2]	Act. DAC value [V] or [mA]	-	3	-	-
P0776[2]	Type of DAC	0	2	CT	N
P0777[2]	Value x1 of DAC scaling	0.0	2	CUT	N
P0778[2]	Value y1 of DAC scaling	0	2	CUT	N
P0779[2]	Value x2 of DAC scaling	100.0	2	CUT	N
P0780[2]	Value y2 of DAC scaling	20	2	CUT	N
P0781[2]	Width of DAC deadband	0	3	CUT	N

Setpoint Channel and Ramp Generator (P0004 = 10)

ParNr	ParText	Default	Level	DS	QC
P1000[3]	Selection of frequency setpoint	2	1	CT	Q
P1001[3]	Fixed frequency 1	0.00	3	CUT	N
P1002[3]	Fixed frequency 2	5.00	3	CUT	N
P1003[3]	Fixed frequency 3	10.00	3	CUT	N
P1004[3]	Fixed frequency 4	15.00	3	CUT	N
P1005[3]	Fixed frequency 5	20.00	3	CUT	N
P1006[3]	Fixed frequency 6	25.00	3	CUT	N
P1007[3]	Fixed frequency 7	30.00	3	CUT	N
P1008[3]	Fixed frequency 8	35.00	3	CUT	N
P1009[3]	Fixed frequency 9	40.00	3	CUT	N
P1010[3]	Fixed frequency 10	45.00	3	CUT	N
P1011[3]	Fixed frequency 11	50.00	3	CUT	N
P1012[3]	Fixed frequency 12	55.00	3	CUT	N
P1013[3]	Fixed frequency 13	60.00	3	CUT	N
P1016	Fixed frequency mode - Bit 0	1	3	CT	N
P1014[3]	Fixed frequency 14	65.00	3	CUT	N
P1017	Fixed frequency mode - Bit 1	1	3	CT	N
P1015[3]	Fixed frequency 15	65.00	3	CUT	N
P1018	Fixed frequency mode - Bit 2	1	3	CT	N
P1019	Fixed frequency mode - Bit 3	1	3	CT	N
r1024	CO: Act. fixed frequency	-	3	-	-
P1025	Fixed frequency mode - Bit 4	1	3	CT	N

ParNr	ParText	Default	Level	DS	QC
P1027	Fixed frequency mode - Bit 5	1	3	CT	N
P1032	Inhibit reverse direction of MOP	1	3	CT	N
P1031[3]	Setpoint memory of the MOP	0	3	CUT	N
P1040[3]	Setpoint of the MOP	5.00	2	CUT	N
r1050	CO: Act. Output freq. of the MOP	-	3	-	-
P1070[3]	CI: Main setpoint	755:0	3	CT	N
P1071[3]	CI: Main setpoint scaling	1:0	3	CT	N
P1075[3]	CI: Additional setpoint	0:0	3	CT	N
r1078	CO: Total frequency setpoint	-	3	-	-
P1076[3]	CI: Additional setpoint scaling	1:0	3	CT	N
P1080[3]	Min. frequency	0.00	1	CUT	Q
P1082[3]	Max. frequency	50.00	1	CT	Q
P1091[3]	Skip frequency 1	0.00	3	CUT	N
P1092[3]	Skip frequency 2	0.00	3	CUT	N
P1093[3]	Skip frequency 3	0.00	3	CUT	N
P1094[3]	Skip frequency 4	0.00	3	CUT	N
P1101[3]	Skip frequency bandwidth	2.00	3	CUT	N
r1114	CO: Freq. setp. after dir. ctrl.	-	3	-	-
r1119	CO: Freq. setpoint before RFG	-	3	-	-
P1120[3]	Ramp-up time	10.00	1	CUT	Q
P1121[3]	Ramp-down time	30.00	1	CUT	Q
P1130[3]	Ramp-up initial rounding time	0.00	2	CUT	N
P1131[3]	Ramp-up final rounding time	0.00	2	CUT	N
P1132[3]	Ramp-down initial rounding time	0.00	2	CUT	N
P1133[3]	Ramp-down final rounding time	0.00	2	CUT	N
P1134[3]	Rounding type	0	2	CUT	N
P1135[3]	OFF3 ramp-down time	5.00	2	CUT	Q
r1170	CO: Frequency setpoint after RFG	-	3	-	-

Drive Features (P0004 = 12)

ParNr	ParText	Default	Level	DS	QC
P0005[3]	Display selection	21	2	CUT	N
P0006	Display mode	2	3	CUT	N
P0007	Backlight delay time	0	3	CUT	N
P0011	Lock for user defined parameter	0	3	CUT	N
P0012	Key for user defined parameter	0	3	CUT	N
P0013[20]	User defined parameter	0	3	CUT	N
P1200	Flying start	0	3	CUT	N
P1202[3]	Motor-current: Flying start	100	3	CUT	N
P1203[3]	Search rate: Flying start	100	3	CUT	N
P1210	Automatic restart	1	3	CUT	N
P1211	Number of restart attempts	3	3	CUT	N
P1212	Time to first restart	30	3	CUT	N
P1213	Restart time increment	30	3	CUT	N
P1215	Holding brake enable	0	2	T	N

ParNr	ParText	Default	Level	DS	QC
P1216	Holding brake release delay	1.0	2	T	N
P1217	Holding time after ramp down	1.0	2	T	N
P1232[3]	DC braking current	100	3	CUT	N
P1233[3]	Duration of DC braking	0	3	CUT	N
P1234[3]	DC braking start frequency	650.00	3	CUT	N
P1236[3]	Compound braking current	0	3	CUT	N
r1242	CO: Switch-on level of Vdc-max	-	3	-	-
P1240[3]	Configuration of Vdc controller	1	3	CT	N
P1243[3]	Dynamic factor of Vdc-max	100	3	CUT	N
P1254	Auto detect Vdc switch-on levels	1	3	CT	N
P1253[3]	Vdc-controller output limitation	10	3	CUT	N
r1261	BO: Contactor control word	-	2	-	-
P1260[3]	source of changeover control	0	2	CT	N
P1262[3]	Bypass dead time	1.000	2	CUT	N
P1263[3]	De-Bypass time	1.0	2	CUT	N
P1264[3]	Bypass time	1.0	2	CUT	N
P1265[3]	Bypass frequency	50.00	2	CT	N
P1266[3]	Bl: Bypass command	0:0	2	CT	N

Motor Control (P0004 = 13)

ParNr	ParText	Default	Level	DS	QC
r0020	CO: Act. frequency setpoint	-	3	-	-
r0021	CO: Act. frequency	-	3	-	-
r0022	Act. rotor speed	-	3	-	-
r0024	CO: Act. output frequency	-	3	-	-
r0025	CO: Act. output voltage	-	3	-	-
r0027	CO: Act. output current	-	3	-	-
r0032	CO: Act. power	-	3	-	-
r0038	CO: Act. power factor	-	3	-	-
r0056	CO/BO: Status of motor control	-	3	-	-
r0061	CO: Act. rotor speed	-	3	-	-
r0065	CO: Slip frequency	-	3	-	-
r0067	CO: Act. output current limit	-	3	-	-
r0071	CO: Max. output voltage	-	3	-	-
r0086	CO: Act. active current	-	3	-	-
P0095[10]	Cl: Display PZD signals	0:0	3	CT	N
r0096[10]	PZD signals	-	3	-	-
P1300[3]	Control mode	1	3	CT	Q
P1310[3]	Continuous boost	50.0	3	CUT	N
P1311[3]	Acceleration boost	0.0	3	CUT	N
P1312[3]	Starting boost	0.0	3	CUT	N
P1316[3]	Boost end frequency	20.0	3	CUT	N
P1320[3]	Programmable V/f freq. coord. 1	0.00	3	CT	N
P1321[3]	Programmable V/f volt. coord. 1	0.0	3	CUT	N
P1322[3]	Programmable V/f freq. coord. 2	0.00	3	CT	N

ParNr	ParText	Default	Level	DS	QC
P1323[3]	Programmable V/f volt. coord. 2	0.0	3	CUT	N
P1324[3]	Programmable V/f freq. coord. 3	0.00	3	CT	N
P1325[3]	Programmable V/f volt. coord. 3	0.0	3	CUT	N
P1330[3]	CI: Voltage setpoint	0:0	3	T	N
P1333[3]	Start frequency for FCC	10.0	3	CUT	N
r1337	CO: V/f slip frequency	-	3	-	-
P1335[3]	Slip compensation	0.0	3	CUT	N
P1336[3]	Slip limit	250	3	CUT	N
P1338[3]	Resonance damping gain V/f	0.00	3	CUT	N
P1340[3]	I _{max} controller prop. gain	0.000	3	CUT	N
r1343	CO: I _{max} controller freq. output	-	3	-	-
P1341[3]	I _{max} controller integral time	0.300	3	CUT	N
r1344	CO: I _{max} controller volt. output	-	3	-	-
P1345[3]	I _{max} controller prop. gain	0.250	3	CUT	N
P1346[3]	I _{max} controller integral time	0.300	3	CUT	N
P1350[3]	Voltage soft start	0	3	CUT	N

Communication (P0004 = 20)

ParNr	ParText	Default	Level	DS	QC
P0918	CB address	3	2	CT	N
P0927	Parameter changeable via	15	3	CUT	N
r0965	Profibus profile	-	3	-	-
r0967	Control word 1	-	3	-	-
r0968	Status word 1	-	3	-	-
r0964[5]	Firmware version data	-	3	-	-
P0971	Transfer data from RAM to EEPROM	0	3	CUT	N
P2000[3]	Reference frequency	50.00	2	CT	N
P2001[3]	Reference voltage	1000	3	CT	N
P2002[3]	Reference current	0.10	3	CT	N
P2003[3]	Reference torque	0.75	3	CT	N
r2004[3]	Reference power	-	3	-	-
P2009[2]	USS normalization	0	3	CT	N
P2010[2]	USS baudrate	6	3	CUT	N
P2011[2]	USS address	0	3	CUT	N
P2012[2]	USS PZD length	2	3	CUT	N
P2013[2]	USS PKW length	127	3	CUT	N
P2014[2]	USS telegram off time	0	3	CT	N
r2015[8]	CO: PZD from BOP link (USS)	-	3	-	-
P2016[8]	CI: PZD to BOP link (USS)	52:0	3	CT	N
r2018[8]	CO: PZD from COM link (USS)	-	3	-	-
r2024[2]	USS error-free telegrams	-	3	-	-
P2019[8]	CI: PZD to COM link (USS)	52:0	3	CT	N
r2025[2]	USS rejected telegrams	-	3	-	-
r2026[2]	USS character frame error	-	3	-	-
r2027[2]	USS overrun error	-	3	-	-

ParNr	ParText	Default	Level	DS	QC
r2028[2]	USS parity error	-	3	-	-
r2029[2]	USS start not identified	-	3	-	-
r2030[2]	USS BCC error	-	3	-	-
r2032	BO: CtrlWrd1 from BOP link (USS)	-	3	-	-
r2031[2]	USS length error	-	3	-	-
r2033	BO: CtrlWrd2 from BOP link (USS)	-	3	-	-
r2036	BO: CtrlWrd1 from COM link (USS)	-	3	-	-
r2037	BO: CtrlWrd2 from COM link (USS)	-	3	-	-
P2040	CB telegram off time	20	3	CT	N
P2041[5]	CB parameter	0	3	CT	N
r2050[8]	CO: PZD from CB	-	3	-	-
r2053[5]	CB identification	-	3	-	-
P2051[8]	CI: PZD to CB	52:0	3	CT	N
r2054[7]	CB diagnosis	-	3	-	-
r2090	BO: Control word 1 from CB	-	3	-	-
r2091	BO: Control word 2 from CB	-	3	-	-

Alarms, Warnings and Monitoring (P0004 = 21)

ParNr	ParText	Default	Level	DS	QC
r0947[8]	Last fault code	-	3	-	-
r0948[12]	Fault time	-	3	-	-
r0949[8]	Fault value	-	3	-	-
P0952	Total number of faults	0	3	CT	N
P2100[3]	Alarm number selection	0	3	CT	N
P2101[3]	Stop reaction value	0	3	CT	N
r2110[4]	Warning number	-	3	-	-
P2111	Total number of warnings	0	3	CT	N
r2114[2]	Run time counter	-	3	-	-
P2115[3]	AOP real time clock	0	3	CT	N
P2150[3]	Hysteresis frequency f_hys	3.00	3	CUT	N
P2151[3]	CI: Monitoring speed setpoint	0:0	3	CUT	N
P2152[3]	CI: Act. Monitoring speed	0:0	3	CUT	N
P2153[3]	Time-constant speed filter	5	3	CUT	N
P2155[3]	Threshold frequency f_1	30.00	3	CUT	N
P2156[3]	Delay time of threshold freq f_1	10	3	CUT	N
P2157[3]	Threshold frequency f_2	30.00	3	CUT	N
P2158[3]	Delay time of threshold freq f_2	10	3	CUT	N
P2159[3]	Threshold frequency f_3	30.00	3	CUT	N
P2160[3]	Delay time of threshold freq f_3	10	3	CUT	N
P2161[3]	Min. threshold for freq. Setp.	3.00	3	CUT	N
P2162[3]	Hysteresis freq. For overspeed	20.00	3	CUT	N
P2163[3]	Entry freq. For perm. Deviation	3.00	3	CUT	N
P2164[3]	Hysteresis frequency deviation	3.00	3	CUT	N
P2165[3]	Delay time permitted deviation	10	3	CUT	N
P2166[3]	Delay time ramp up completed	10	3	CUT	N

ParNr	ParText	Default	Level	DS	QC
P2167[3]	Switch-off frequency f_off	1.00	3	CUT	N
P2168[3]	Delay time T_off	10	3	CUT	N
r2169	CO: Act. Filtered frequency	-	3	-	-
P2170[3]	Threshold current I_thresh	100.0	3	CUT	N
P2171[3]	Delay time current	10	3	CUT	N
P2172[3]	Threshold DC-link voltage	800	3	CUT	N
P2173[3]	Delay time DC-link voltage	10	3	CUT	N
P2174[3]	Torque threshold T_thresh	5.13	3	CUT	N
P2176[3]	Delay time for torque threshold	10	3	CUT	N
P2177[3]	Delay time for motor is blocked	10	3	CUT	N
P2178[3]	Delay time for motor pulled out	10	3	CUT	N
P2179	Current limit for no load ident.	3.0	3	CUT	N
P2180	Delay time for no load ident.	2000	3	CUT	N
P2181[3]	Belt failure detection mode	0	3	CT	N
P2182[3]	Belt threshold frequency 1	5.00	3	CUT	N
P2183[3]	Belt threshold frequency 2	30.00	3	CUT	N
P2184[3]	Belt threshold frequency 3	50.00	3	CUT	N
P2185[3]	Upper torque threshold 1	99999.0	3	CUT	N
P2186[3]	Lower torque threshold 1	0.0	3	CUT	N
P2187[3]	Upper torque threshold 2	99999.0	3	CUT	N
P2188[3]	Lower torque threshold 2	0.0	3	CUT	N
P2189[3]	Upper torque threshold 3	99999.0	3	CUT	N
P2190[3]	Lower torque threshold 3	0.0	3	CUT	N
P2192[3]	Time delay for belt failure	10	3	CUT	N
r2197	CO/BO: Monitoring word 1	-	3	-	-
r2198	CO/BO: Monitoring word 2	-	3	-	-

PI Controller (P0004 = 22)

ParNr	ParText	Default	Level	DS	QC
P2200[3]	BI: Enable PID controller	0:0	2	CUT	N
P2201[3]	Fixed PID setpoint 1	0.00	3	CUT	N
P2202[3]	Fixed PID setpoint 2	10.00	3	CUT	N
P2203[3]	Fixed PID setpoint 3	20.00	3	CUT	N
P2204[3]	Fixed PID setpoint 4	30.00	3	CUT	N
P2205[3]	Fixed PID setpoint 5	40.00	3	CUT	N
P2206[3]	Fixed PID setpoint 6	50.00	3	CUT	N
P2207[3]	Fixed PID setpoint 7	60.00	3	CUT	N
P2208[3]	Fixed PID setpoint 8	70.00	3	CUT	N
P2209[3]	Fixed PID setpoint 9	80.00	3	CUT	N
P2210[3]	Fixed PID setpoint 10	90.00	3	CUT	N
P2211[3]	Fixed PID setpoint 11	100.00	3	CUT	N
P2212[3]	Fixed PID setpoint 12	110.00	3	CUT	N
P2213[3]	Fixed PID setpoint 13	120.00	3	CUT	N
P2214[3]	Fixed PID setpoint 14	130.00	3	CUT	N
P2215[3]	Fixed PID setpoint 15	130.00	3	CUT	N

ParNr	ParText	Default	Level	DS	QC
P2216	Fixed PID setpoint mode - Bit 0	1	3	CT	N
P2217	Fixed PID setpoint mode - Bit 1	1	3	CT	N
P2218	Fixed PID setpoint mode - Bit 2	1	3	CT	N
P2219	Fixed PID setpoint mode - Bit 3	1	3	CT	N
r2224	CO: Act. fixed PID setpoint	-	3	-	-
P2225	Fixed PID setpoint mode - Bit 4	1	3	CT	N
P2227	Fixed PID setpoint mode - Bit 5	1	3	CT	N
P2232	Inhibit rev. direct. of PID-MOP	1	3	CT	N
P2231[3]	Setpoint memory of PID-MOP	1	3	CUT	N
P2240[3]	Setpoint of PID-MOP	10.00	3	CUT	N
r2250	CO: Output setpoint of PID-MOP	-	3	-	-
P2255	PID setpoint gain factor	100.00	3	CUT	N
P2253[3]	CI: PID setpoint	2250:0	2	CUT	N
P2256	PID trim gain factor	100.00	3	CUT	N
P2257	Ramp-up time for PID setpoint	1.00	2	CUT	N
P2254[3]	CI: PID trim source	0:0	3	CUT	N
P2258	Ramp-down time for PID setpoint	1.00	2	CUT	N
r2260	CO: PID setpoint after PID-RFG	-	2	-	-
P2261	PID setpoint filter timeconstant	0.00	3	CUT	N
r2262	CO: Filtered PID setp. after RFG	-	3	-	-
P2263	PID controller type	0	3	T	N
P2265	PID feedback filter timeconstant	0.00	2	CUT	N
r2266	CO: PID filtered feedback	-	2	-	-
P2264[3]	CI: PID feedback	755:1	2	CUT	N
P2267	Max. value for PID feedback	100.00	3	CUT	N
P2268	Min. value for PID feedback	0.00	3	CUT	N
P2269	Gain applied to PID feedback	100.00	3	CUT	N
P2270	PID feedback function selector	0	3	CUT	N
P2271	PID transducer type	0	2	CUT	N
r2272	CO: PID scaled feedback	-	2	-	-
r2273	CO: PID error	-	2	-	-
P2274	PID derivative time	0.000	2	CUT	N
P2280	PID proportional gain	3.000	2	CUT	N
P2285	PID integral time	0.000	2	CUT	N
P2291	PID output upper limit	100.00	2	CUT	N
P2292	PID output lower limit	0.00	2	CUT	N
P2293	Ramp-up /-down time of PID limit	1.00	3	CUT	N
r2294	CO: Act. PID output	-	2	-	-
P2370[3]	Motor staging stop mode	0	3	CT	N
P2371[3]	External motor configuration	0	3	CT	N
P2372[3]	Enable motor cycling	0	3	CT	N
P2373[3]	Motor staging hysteresis	20.0	3	CUT	N
P2374[3]	Motor staging delay	30	3	CUT	N
P2375[3]	Motor destaging delay	30	3	CUT	N
P2376[3]	Delay override	25.0	3	CUT	N

ParNr	ParText	Default	Level	DS	QC
P2377[3]	Delay override lockout timer	30	3	CUT	N
P2378[3]	Staging frequency f, %fMax	50.0	3	CUT	N
r2379	CO/BO: Status of motor staging	-	3	-	-
P2380[3]	Motor hours run	0	3	CUT	N
P2390	Energy saving setpoint	0	3	CUT	N
P2391	Energy saving timer	0	3	CT	N
P2392	Energy saving restart setpoint	0	3	CT	N
P2800	Enable FFBs	0	3	CUT	N
r2811	BO: AND 1	-	3	-	-
P2810[2]	BI: AND 1	0:0	3	CUT	N
r2813	BO: AND 2	-	3	-	-
P2812[2]	BI: AND 2	0:0	3	CUT	N
r2815	BO: AND 3	-	3	-	-
P2802[14]	Activate FFBs	0	3	CUT	N
P2814[2]	BI: AND 3	0:0	3	CUT	N
r2817	BO: OR 1	-	3	-	-
P2801[17]	Activate FFBs	0	3	CUT	N
P2816[2]	BI: OR 1	0:0	3	CUT	N
r2819	BO: OR 2	-	3	-	-
P2818[2]	BI: OR 2	0:0	3	CUT	N
r2821	BO: OR 3	-	3	-	-
P2820[2]	BI: OR 3	0:0	3	CUT	N
r2823	BO: XOR 1	-	3	-	-
P2822[2]	BI: XOR 1	0:0	3	CUT	N
r2825	BO: XOR 2	-	3	-	-
P2824[2]	BI: XOR 2	0:0	3	CUT	N
r2827	BO: XOR 3	-	3	-	-
P2826[2]	BI: XOR 3	0:0	3	CUT	N
P2828	BI: NOT 1	0:0	3	CUT	N
r2829	BO: NOT 1	-	3	-	-
P2830	BI: NOT 2	0:0	3	CUT	N
r2831	BO: NOT 2	-	3	-	-
P2832	BI: NOT 3	0:0	3	CUT	N
r2833	BO: NOT 3	-	3	-	-
r2835	BO: Q D-FF 1	-	3	-	-
r2836	BO: NOT-Q D-FF 1	-	3	-	-
P2834[4]	BI: D-FF 1	0:0	3	CUT	N
r2838	BO: Q D-FF 2	-	3	-	-
r2839	BO: NOT-Q D-FF 2	-	3	-	-
P2837[4]	BI: D-FF 2	0:0	3	CUT	N
r2841	BO: Q RS-FF 1	-	3	-	-
P2840[2]	BI: RS-FF 1	0:0	3	CUT	N
r2842	BO: NOT-Q RS-FF 1	-	3	-	-
r2844	BO: Q RS-FF 2	-	3	-	-
P2843[2]	BI: RS-FF 2	0:0	3	CUT	N

ParNr	ParText	Default	Level	DS	QC
r2845	BO: NOT-Q RS-FF 2	-	3	-	-
P2846[2]	BI: RS-FF 3	0:0	3	CUT	N
r2847	BO: Q RS-FF 3	-	3	-	-
r2848	BO: NOT-Q RS-FF 3	-	3	-	-
P2849	BI: Timer 1	0:0	3	CUT	N
P2850	Delay time of timer 1	0	3	CUT	N
P2851	Mode timer 1	0	3	CUT	N
r2852	BO: Timer 1	-	3	-	-
r2853	BO: Nout timer 1	-	3	-	-
P2854	BI: Timer 2	0:0	3	CUT	N
P2855	Delay time of timer 2	0	3	CUT	N
P2856	Mode timer 2	0	3	CUT	N
r2857	BO: Timer 2	-	3	-	-
r2858	BO: Nout timer 2	-	3	-	-
P2859	BI: Timer 3	0:0	3	CUT	N
P2860	Delay time of timer 3	0	3	CUT	N
P2861	Mode timer 3	0	3	CUT	N
r2862	BO: Timer 3	-	3	-	-
r2863	BO: Nout timer 3	-	3	-	-
P2864	BI: Timer 4	0:0	3	CUT	N
P2865	Delay time of timer 4	0	3	CUT	N
P2866	Mode timer 4	0	3	CUT	N
r2867	BO: Timer 4	-	3	-	-
r2868	BO: Nout timer 4	-	3	-	-
r2870	CO: ADD 1	-	3	-	-
P2869[2]	CI: ADD 1	755:0	3	CUT	N
r2872	CO: ADD 2	-	3	-	-
P2871[2]	CI: ADD 2	755:0	3	CUT	N
r2874	CO: SUB 1	-	3	-	-
P2873[2]	CI: SUB 1	755:0	3	CUT	N
r2876	CO: SUB 2	-	3	-	-
P2875[2]	CI: SUB 2	755:0	3	CUT	N
r2878	CO: MUL 1	-	3	-	-
P2877[2]	CI: MUL 1	755:0	3	CUT	N
r2880	CO: MUL 2	-	3	-	-
P2879[2]	CI: MUL 2	755:0	3	CUT	N
r2882	CO: DIV 1	-	3	-	-
P2881[2]	CI: DIV 1	755:0	3	CUT	N
r2884	CO: DIV 2	-	3	-	-
P2883[2]	CI: DIV 2	755:0	3	CUT	N
r2886	BO: CMP 1	-	3	-	-
P2885[2]	CI: CMP 1	755:0	3	CUT	N
r2888	BO: CMP 2	-	3	-	-
P2887[2]	CI: CMP 2	755:0	3	CUT	N
P2889	CO: Fixed setpoint 1 in [%]	0	3	CUT	N
P2890	CO: Fixed setpoint 2 in [%]	0	3	CUT	N

6 Troubleshooting

This Chapter contains:

- An overview of the operating statuses of the inverter with the SDP
- Notes on troubleshooting with the BOP-2
- A list of the alarms and fault messages

6.1	Troubleshooting with the SDP.....	74
6.2	Troubleshooting with the BOP-2	75
6.3	Fault messages	76
6.4	Alarm messages.....	80



WARNING

- ◆ Repairs on equipment may only be carried out by **Siemens Service**, by repair centers **authorized by Siemens** or by qualified personnel who are thoroughly acquainted with all the warnings and operating procedures contained in this manual.
- ◆ Any defective parts or components must be replaced using parts contained in the relevant spare parts list.
- ◆ Disconnect the power supply before opening the equipment for access

6.1 Troubleshooting with the SDP

Table 6-1 explains the meaning of the various states of the LEDs on the SDP.

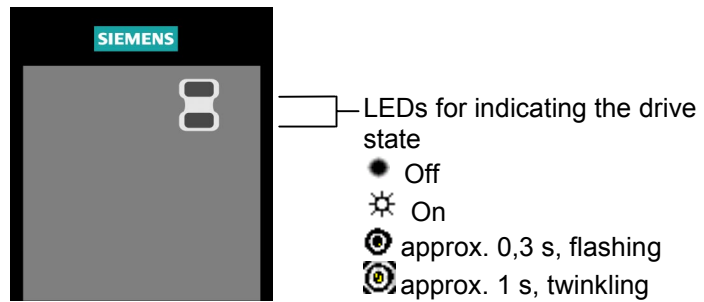

Table 6-1 Inverter conditions indicated by the LEDs on the SDP

● ●	Mains not present	☀	Fault inverter temperature
☀ ☀	Ready to run	⦿ ⦿	Warning current limit - both LEDs twinkling same time
● ☀	Inverter fault - other than the ones listed below	⦿ ⦿	Other warnings - both LEDs twinkling alternatively
☀ ●	Inverter running	⦿ ⦿	Undervoltage trip / undervoltage warning
● ⦿	Fault overcurrent	⦿ ⦿	Drive is not in ready state
⦿ ●	Fault overvoltage	⦿ ⦿	ROM failure - Both LEDs flashing same time
⦿ ☀	Fault motor overtemperature	⦿ ⦿	RAM failure - Both LEDs flashing alternatively

6.2 Troubleshooting with the BOP-2

Warnings and faults are displayed on the BOP-2 with Axxx and Fxxx respectively. The individual messages are shown in Section 6.3.

If the motor fails to start when the ON command has been given:

- Check that P0010 = 0.
- Check that a valid ON signal is present.
- Check that P0700 = 2 (for digital input control) or P0700 = 1 (for BOP-2 control).
- Check that the setpoint is present (0 to 10V on Terminal 3) or the setpoint has been entered into the correct parameter, depending upon the setpoint source (P1000). See the Parameter List for further details.

If the motor fails to run after changing the parameters, set P0010 = 30 then P0970 = 1 and press **P** to reset the inverter to the factory default parameter values.

Now use a switch between terminals **5** and **8** on the control board. The drive should now run to the defined setpoint by analogue input.

NOTICE

Motor data must relate to the inverter data power range and voltage.

6.3 Fault messages

In the event of a failure, the inverter switches off and a fault code appears on the display.

NOTE

To reset the fault code, one of three methods listed below can be used:

1. Cycle the power to the drive.
2. Press the  button on the BOP-2.
3. Via Digital Input 3 (default setting)

Fault	Possible Causes	Diagnose & Remedy	Reaction
F0001 OverCurrent	<ul style="list-style-type: none"> ➤ Motor power (P0307) does not correspond to the inverter power (r0206) ➤ Motor lead short circuit ➤ Earth faults 	Check the following: <ol style="list-style-type: none"> 1. Motor power (P0307) must correspond to inverter power (r0206). 2. Cable length limits must not be exceeded. 3. Motor cable and motor must have no short-circuits or earth faults 4. Motor parameters must match the motor in use 5. Value of stator resistance (P0350) must be correct 6. Motor must not be obstructed or overloaded <ul style="list-style-type: none"> ➤ Increase the ramp time ➤ Reduce the boost level 	Off1
F0002 OverVoltage	<ul style="list-style-type: none"> ➤ DC-link voltage (r0026) exceeds trip level (P2172) ➤ Overvoltage can be caused either by too high main supply voltage or if motor is in regenerative mode. ➤ Regenerative mode can be cause by fast ramp downs or if the motor is driven from an active load. 	Check the following: <ol style="list-style-type: none"> 1. Supply voltage (P0210) must lie within limits indicated on rating plate . 2. DC-link voltage controller must be enabled (P1240) and parameterized properly. 3. Ramp-down time (P1121) must match inertia of load. 4. Required braking power must lie within specified limits. <p>NOTE Higher inertia requires longer ramp times; otherwise, apply braking resistor.</p>	Off1
F0003 UnderVoltage	<ul style="list-style-type: none"> ➤ Main supply failed. ➤ Shock load outside specified limits. 	Check the following: <ol style="list-style-type: none"> 1. Supply voltage (P0210) must lie within limits indicated on rating plate. 2. Supply must not be susceptible to temporary failures or voltage reductions. 	Off1
F0004 Inverter Over Temperature	<ul style="list-style-type: none"> ➤ Ventilation inadequate ➤ Ambient temperature is too high. 	Check the following: <ol style="list-style-type: none"> 1. Fan must turn when inverter is running 2. Pulse frequency must be set to default value 3. Ambient temperature could be higher than specified for the inverter 	Off1
F0005 Inverter I²T	<ul style="list-style-type: none"> ➤ Inverter overloaded. ➤ Duty cycle too demanding. ➤ Motor power (P0307) exceeds inverter power capability (r0206). 	Check the following: <ol style="list-style-type: none"> 1. Load duty cycle must lie within specified limits. 2. Motor power (P0307) must match inverter power (r0206) 	Off1

Fault	Possible Causes	Diagnose & Remedy	Reaction
F0011 Motor Over Temperature	Motor overloaded	Check the following: 1. Load duty cycle must be correct 2. Motor nominal overtemperatures (P0626-P0628) must be correct 3. Motor temperature warning level (P0604) must match	Off1
F0012 Inverter temp. signal lost	Wire breakage of inverter temperature (heatsink) sensor		Off1
F0015 Motor temperature signal lost	Open or short circuit of motor temperature sensor. If signal loss is detected, temperature monitoring switches over to monitoring with the motor thermal model.		Off1
F0020 Mains Phase Missing	Fault occurs if one of the three input phases are missed and the pulses are enabled and drive is loaded	check the input wiring of the mains phases	Off1
F0021 Earth fault	Fault occurs if the sum of the phase currents is higher than 5 % of the nominal inverter current. NOTE This fault only occurs on inverters that have 3 current sensors. Framesizes D to F		Off1
F0022 Powerstack fault	That hardware fault (P0947 = 22 and P0949 = 1) caused by the following events: (1) DC-link overcurrent = short circuit of IGBT (2) Short circuit of chopper (3) Earth fault (4) I/O board is not properly inserted. ➤ Framesize C (1),(2),(3),(4) ➤ Framesizes D to E (1),(2),(4) ➤ FramesizeF(2),(4) Since all these faults are assigned to one signal on the power stack, it is not possible to establish which one actually occurred.	Check the I/O board. It has to be fully pressed home.	Off1
F0023 Output fault	Fault caused by the following events: One phase of output is disconnected		Off1
F0024 Rectifier Over Temperature	➤ Ventilation inadequate ➤ Fan inoperative ➤ Ambient temperature is too high.	Check the following: 1. Fan must turn when inverter is running 2. Pulse frequency must be set to default value 3. Ambient temperature could be higher than specified for the inverter	Off1
F0030 Fan has failed	Fan no longer working	1. Fault cannot be masked while options module (AOP or BOP) is connected. 2. Need a new fan.	Off1
F0035 Auto restart after n	Auto restart fault after n-restart try		Off1
F0040 Automatic Calibration Failure			Off1

Fault	Possible Causes	Diagnose & Remedy	Reaction
F0041 Motor Data Identification Failure	Motor data identification failed. Alarm value =0: Load missing Alarm value =1: Current limit level reached during identification. Alarm value =2: Identified stator resistance less than 0.1% or greater than 100%. Alarm value =3: Identified rotorresistance less than 0.1% or greater than 100%. Alarm value =4: Identified stator reactance less than 50% and greater than 500% Alarm value =5: Identified main reactance less than 50% and greater than 500% Alarm value =6: Identified rotor time constant less than 10ms or greater than 5s Alarm value =7: Identified total leakage reactance less than 5% and greater than 50% Alarm value =8: Identified stator leakage reactance less than 25% and greater than 250% Alarm value =9: Identified rotor leakage inductance less than 25% and greater than 250% Alarm value = 20: Identified IGBT on-voltage less than 0.5 or greater than 10V Alarm value = 30: Current controller at voltage limit Alarm value = 40: Inconsistence of identified data set, at least one identification failed Percentage values based on the impedance $Z_b = V_{mot,nom} / \sqrt{3} / I_{mot,nom}$	0: Check that the motor is connected to the inverter. 1-40: Check if motor data in P304-311 are correct. Check what type of motor wiring is required (star, delta).	Off1
F0051 Parameter EEPROM Fault	Read or write failure while saving non-volatile parameter.	1. Factory Reset and new parameterization 2. Change drive	Off1
F0052 power stack Fault	Read failure for power stack information or invalid data.	Change drive	Off1
F0053 IO Eeprom Fault	Read failure for IO EEPROM information or invalid data.	1. Check data 2. Change IO module	Off1
F0054 Wrong IO Board	<ul style="list-style-type: none"> ➤ Wrong IO board is connected. ➤ No ID detected on IO board, No data. 	1. Check data 2. Change IO module	Off1
F0060 Asic Timeout	Internal communications failure	1. If fault persists, change inverter, 2. Contact Service Department	Off1
F0070 CB setpoint fault	No setpoint values from CB (communication board) during telegram off time	Check CB and communication partner	Off1

Fault	Possible Causes	Diagnose & Remedy	Reaction
F0071 USS (BOP-link) setpoint fault	No setpoint values from USS during telegram off time	Check USS master	Off1
F0072 USS (COMM link) setpoint fault	No setpoint values from USS during telegram off time	Check USS master	Off1
F0080 ADC lost input signal	Broken wire signal out of limits		Off1
F0085 External Fault	External fault triggered via terminal inputs	Disable terminal input for fault trigger.	Off1
F0090 Encoder feedback loss	Signal from Encoder lost	<ol style="list-style-type: none"> 1. Check encoder fitted. If encoder not fitted, set P400 = 0 and select SLVC mode (P1300 = 20 or 22) 2. Check connections between encoder and inverter 3. Check encoder not faulty (select P1300 = 0, run at fixed speed, check encoder feedback signal in P66) 4. Increase encoder loss threshold in P492 	Off1
F0101 Stack Overflow	Software error or processor failure	Run self test routines	Off1
F0221 PID Feedback below min. value	PID Feedback below min. value P2268.	Change value of P2268. Adjust feedback gain.	Off1
F0222 PID Feedback above max. value	PID feedback above max. value P2267.	<ol style="list-style-type: none"> 1. Change value of P2267. 2. Adjust feedback gain. 	Off1
F0450 BIST Tests Failure	Fault value: <ol style="list-style-type: none"> 1 Some power section tests have failed 2 Some control board tests have failed 4 Some functional tests have failed 16 Internal RAM failed on power-up check 	<ol style="list-style-type: none"> 1. Drive may run but some features will not work properly. 2. Replace drive. 	Off1

Fault	Possible Causes	Diagnose & Remedy	Reaction
F0452 Belt Failure Detected	Load conditions on motor indicate belt failure or mechanical fault.	<p>Check the following:</p> <ol style="list-style-type: none"> 1. No breakage, seizure or obstruction of drive train. 2. If using an external speed sensor, check for correct function. Check parameters: P0409 (pulse per min at rated speed), P2191 (Belt failure speed tolerance), P2192 (delay time for permitted deviation) 3. If using the torque envelope, check parameters: <ul style="list-style-type: none"> P2182 (threshold frequency f1) P2183 (threshold frequency f2) P2184 (threshold frequency f3) P2185 (upper torque threshold 1) P2186 (lower torque threshold 1) P2187 (upper torque threshold 2) P2188 (lower torque threshold 2) P2189 (upper torque threshold 3) P2190 (lower torque threshold 3) P2192 (delay time for permitted deviation) 4. Apply lubrication if required. 	Off1

6.4 Alarm messages

Alarm	Possible Causes	Diagnose & Remedy
A0501 Current Limit	<ul style="list-style-type: none"> ➤ Motor power does not correspond to the inverter power ➤ Motor leads are too long ➤ Earth faults 	<p>Check the following:</p> <ol style="list-style-type: none"> 1. Motor power (P0307) must correspond to inverter power (r0206). 2. Cable length limits must not be exceeded. 3. Motor cable and motor must have no short-circuits or earth faults 4. Motor parameters must match the motor in use 5. Value of stator resistance (P0350) must be correct 6. Motor must not be obstructed or overloaded <ul style="list-style-type: none"> ➤ Increase the ramp-up-time. ➤ Reduce the boost.
A0502 Overvoltage limit	<ul style="list-style-type: none"> ➤ Overvoltage limit is reached. ➤ This warning can occur during ramp down, if the dc-link controller is disabled (P1240 = 0). 	If this warning is displayed permanently, check drive input voltage .
A0503 UnderVoltage Limit	<ul style="list-style-type: none"> ➤ Main supply failed ➤ Main supply (P0210) and consequently DC-link voltage (R0026) below specified limit (P2172). 	Check main supply voltage (P0210).
A0504 Inverter Over- Temperature	Warning level of inverter heat-sink temperature (P0614) is exceeded, resulting in pulse frequency reduction and/or output frequency reduction (depending on parametrization in (P0610))	<p>Check the following:</p> <ol style="list-style-type: none"> 1. Ambient temperature must lie within specified limits 2. Load conditions and duty cycle must be appropriate
A0505 Inverter I²T	Warning level exceeded, current will be reduced if parameterized (P0610 = 1)	Check that duty cycle lies within specified limits

Alarm	Possible Causes	Diagnose & Remedy
A0506 Inverter duty cycle	Difference between heatsink and IGBT junction temperature exceeds warning limits	Check that duty cycle and shock loads lie within specified limits
A0511 Motor Over-Temperature I²T	<ul style="list-style-type: none"> ➤ Motor overloaded. ➤ Load duty cycle too high. 	<p>Independently of the kind of temperature determination check:</p> <ol style="list-style-type: none"> 1. P0604 motor temperature warning threshold 2. P0625 motor ambient temperature <p>If (P601 = 0 or 1) Check the following:</p> <ol style="list-style-type: none"> 1. Check if name plate data are correct (if not perform quick commissioning) 2. Accurate equivalent circuit data can be found by performing motor identification (P1910=1). 3. Check if motor weight (P344) is reasonable. Change if necessary. 4. Via P626, P627, P628 the standard overtemperatures can be changed, if the motor is nota Siemens standard motor. <p>If (P601 = 2) Check the following:</p> <ol style="list-style-type: none"> 1. Check if temperature shown in r35 is reasonable. 2. Check if the sensor is a KTY84 (other sensors are not supported)
A0512 Motor temperature signal lost	Wire break to motor temperature sensor. If a wire breakage is be detected, temperature monitoring switches over to monitoring with the motor thermal model.	
A0520 Rectifier Over-Temperature	Warning level of rectifier heat-sink temperature (P) is exceeded	<p>Check the following:</p> <ol style="list-style-type: none"> 1. Ambient temperature must lie within specified limits 2. Load conditions and duty cycle must be appropriate 3. Fan must turn when drive is running
A0521 Ambient Over-Temperature	Warning level of ambient temperature (P) is exceeded	<p>Check the following:</p> <ol style="list-style-type: none"> 1. Ambient temperature must lie within specified limits 2. Fan must turn when drive is running 3. fan intake air has to be without any resistance
A0523 Output fault	One phase of output is disconnected	Warning can be masked.
A0541 Motor Data Identification Active	Motor data identification (P1910) selected or running	
A0590 Encoder feedback loss warning	Signal from Encoder lost and Inverter has switched to sensorless vector control	<p>Stop inverter and then</p> <ol style="list-style-type: none"> 1. Check encoder fitted. If encoder not fitted, set P400 = 0 and select SLVC mode (P1300 = 20 or 22) 2. Check connections between encoder and inverter 3. Check encoder not faulty (select P1300 = 0, run at fixed speed, check encoder feedback signal in P66) 4. Increase encoder loss threshold in P492
A0600 RTOS Overrun Warning		
A0700 CB warning 1	CB (communication board) specific	See CB user manual
A0701 CB warning 2	CB (communication board) specific	See CB user manual

Alarm	Possible Causes	Diagnose & Remedy
A0702 CB warning 3	CB (communication board) specific	See CB user manual
A0703 CB warning 4	CB (communication board) specific	See CB user manual
A0704 CB warning 5	CB (communication board) specific	See CB user manual
A0705 CB warning 6	CB (communication board) specific	See CB user manual
A0706 CB warning 7	CB (communication board) specific	See CB user manual
A0707 CB warning 8	CB (communication board) specific	See CB user manual
A0708 CB warning 9	CB (communication board) specific	See CB user manual
A0709 CB warning 10	CB (communication board) specific	See CB user manual
A0710 CB communication error	Communication with CB (communication board) is lost	Check CB hardware
A0711 CB configuration error	CB (communication board) reports a configuration error.	Check CB parameters
A0910 Vdc-max controller deactivated	<p>Vdc max controller has been deactivated, since controller is not capable of keeping DC-link voltage (r0026) within limits (P2172).</p> <ul style="list-style-type: none"> ➤ Occurs if main supply voltage (P0210) is permanently too high. ➤ Occurs if motor is driven by an active load, causing motor to go into regenerative mode. ➤ Occurs at very high load inertias, when ramping down. 	<p>Check the following:</p> <ol style="list-style-type: none"> 1. Input voltage (P0210) must lie within range. 2. Load must be match.
A0911 Vdc-max controller active	Vdc max controller is active; so ramp-down times will be increased automatically to keep DC-link voltage (r0026) within limits (P2172).	
A0912 Vdc-min controller active	<p>Vdc min controller will be activated if DC-link voltage (r0026) falls below minimum level (P2172).</p> <p>The kinetic energy of the motor is used to buffer the DC-link voltage, thus causing deceleration of the drive!</p> <p>So short mains failures do not necessarily lead to an undervoltage trip.</p>	

Alarm	Possible Causes	Diagnose & Remedy
A0920 ADC parameters not set properly.	ADC parameters should not be set to identical values, since this would produce illogical results. Index 0: Parameter settings for output identical Index 1: Parameter settings for input identical Index 2: Parameter settings for input do not correspond to ADC type	
A0921 DAC parameters not set properly.	DAC parameters should not be set to identical values, since this would produce illogical results. Index 0: Parameter settings for output identical Index 1: Parameter settings for input identical Index 2: Parameter settings for output do not correspond to DAC type	
A0922 No load applied to inverter	<ul style="list-style-type: none"> ➤ No Load is applied to the inverter. ➤ As a result, some functions may not work as under normal load conditions. 	
A0952 Belt Failure Detected	Load conditions on motor indicate belt failure or mechanical fault.	<p>Apply lubrication if required.</p> <p>Check the following:</p> <ol style="list-style-type: none"> 1. No breakage, seizure or obstruction of drive train. 2. If using an external speed sensor, check for correct function. Check parameters: <ul style="list-style-type: none"> P0409 (pulse per min at rated speed). P2191 (Belt failure speed tolerance). P2192 (delay time for permitted deviation) 3. If using the torque envelope, check parameters: <ul style="list-style-type: none"> P2182 (threshold frequency f1) P2183 (threshold frequency f2) P2184 (threshold frequency f3) P2185 (upper torque threshold 1) P2186 (lower torque threshold 1) P2187 (upper torque threshold 2) P2188 (lower torque threshold 2) P2189 (upper torque threshold 3) P2190 (lower torque threshold 3) P2192 (delay time for permitted deviation) 4. Apply lubrication if required.

7 MICROMASTER 430 specifications

This Chapter contains:

- Table 7.1 contains the general technical specifications for the MICROMASTER 430 inverter
- Table 7-2 contains terminal tightening torques
- Table 7-3 includes various tables of specific technical data for individual MICROMASTER 430 inverters

Table 7-1 MICROMASTER 430 Performance Ratings

Feature	Specification
Mains Operating Voltage & Power Ranges VT	3 AC 380 to 480 V \pm 10 % 7.50 kW – 90.0 kW (10.0 hp – 120 hp)
Input Frequency	47 to 63 Hz
Output frequency	0 Hz to 650 Hz
Power Factor	\geq 0.7
Inverter Efficiency	96 to 97 %
Overload Capability for variable torque (VT)	40 % for 3 s and 10 % for 60 s within 5 minutes in terms of the nominal output current
Inrush Current	Less than rated input current
Control Method	Linear V/f control, Linear V/f control with FCC, Parabolic V/f control, Multi-point V/f control, V/f control for textile applications, V/f control with FCC for textile applications, V/f control with independent voltage setpoint
Pulse Frequency	2 kHz to 16 kHz (2 kHz steps)
Fixed Frequencies	15, programmable
Skip Frequencies	4, programmable
Setpoint Resolution	0.01 Hz Digital, 0.01 Hz Serial, 10 bit Analogue (motor potentiometer 0.1 Hz [0.1% (in PID mode)])
Digital Inputs	6, programmable (isolated), switchable active high / active low (PNP/NPN)
Analog Input 1	0 - 10 V, 0 - 20 mA and -10 V to +10 V
Analog Input 2	0 - 10 V and 0 - 20 mA
Relay Outputs	3, programmable 30 V DC / 5 A (resistive), 250 V AC 2 A (inductive)
Analogue Output	2, programmable (0 to 20 mA)
Serial Interface	RS-485, optional RS-232
Electromagnetic Compatibility	Optional EMC filters to EN 55011 Class A or B, also Internal Class A filters available selected units
Braking	DC braking, Compound braking
Protection Level	IP20
Temperature range (VT)	-10 °C to +40 °C (14 °F to 104 °F)
Storage Temperature	-40 °C to +70 °C (40 °F bis 158 °F)
Humidity	< 95 % RH – non-condensing
Operational Altitudes	Up to 1000 m above sea level without derating
Protection Features	Undervoltage , Overvoltage, Overload, Ground Faults, Short circuit, Stall Prevention, Motor Blocking Protection, Motor Overtemperature, Inverter Overtemperature, Parameter Interlock
Standards	UL, cUL, CE, C-tick
CE Marked	Conformity with EC Low Voltage Directive 73/23/EEC and Electromagnetic Compatibility Directive 89/336/EEC

Table 7-2 Tightening torques for power terminals

Frame Size		C	D	E	F
Tightening Torque	[Nm]	2.25	10 (max)	10 (max)	50
	[lbf.in]	20	87 (max)	87 (max)	435

Table 7-3 MICROMASTER 430 Specifications

In order to have a UL compliant installation fuses from the SITOR range with the appropriate current rating must be used.

Input voltage range 3 AC 380 V – 480 V, ± 10 %
(with built in Class A Filter), Part 1

Order No.	6SE6430-	2AD27-5CA0	2AD31-1CA0	2AD31-5CA0	2AD31-8DA0	2AD32-2DA0
Motor Output Rating	[kW]	7.5	11.0	15.0	18.5	22.0
	[hp]	10.0	15.0	20.0	25.0	30.0
Output Power	[kVA]	10.1	14.0	19.8	24.4	29.0
VT Input Current	[A]	16.0	22.5	30.5	37.2	43.3
VT Output Cur. Max.	[A]	18.4	26.0	32.0	38.0	45.0
Recommended Fuse	[A]	20	32	35	50	63
		3NA3007	3NA3012	3NA3014	3NA3020	3NA3022
Fuses recommended for UL applications	[A]				50	63
	3NE				1817-0	1818-0
Input Cable Min.	[mm ²]	2.5	4.0	6.0	10.0	10.0
	[awg]	13	11	9	7	7
Input Cable Max.	[mm ²]	10.0	10.0	10.0	35.0	35.0
	[awg]	7	7	7	2	2
Output Cable Min.	[mm ²]	2.5	4.0	6.0	10.0	10.0
	[awg]	13	11	9	7	7
Output Cable Max.	[mm ²]	10.0	10.0	10.0	35.0	35.0
	[awg]	7	7	7	2	2
Weight	[kg]	5.7	5.7	5.7	17.0	17.0
	[lbs]	12.5	12.5	12.5	37.0	37.0
Dimensions	w [mm]	185.0	185.0		275.0	275.0
	h [mm]	245.0	245.0	245.0	520.0	520.0
	d [mm]	195.0	195.0	195.0	245.0	245.0
	w [inches]	7.28	7.28	7.28	10.83	10.83
	h [inches]	9.65	9.65	9.65	20.47	20.47
	d [inches]	7.68	7.68	7.68	9.65	9.65

**Input voltage range 3 AC 380 V – 480 V, ± 10 %
(with built in Class A Filter), Part 2**

Order No.	6SE6430-	2AD33-0DA0	2AD33-7EA0	2AD34-5EA0	2AD35-5FA0	2AD37-5FA0	2AD38-8FA0
Motor Output Rating	[kW]	30.0	37.0	45.0	55.0	75.0	90.0
	[hp]	40.0	50.0	60.0	75.0	100.0	120.0
Output Power	[kVA]	34.3	47.3	57.2	68.6	83.8	110.5
VT Input Current	[A]	59.3	71.7	86.6	103.6	138.5	168.5
VT Output Cur. Max.	[A]	62.0	75.0	90.0	110.0	145.0	178.0
Recommended Fuse	[A]	80	100	125	160	160	200
		3NA3024	3NA3030	3NA3032	3NA3036	3NA3036	3NA3140
Fuses recommended for UL applications	[A]	80	100	125	160	200	200
	3NE	1820-0	1021-0	1022-0	1224-0	1225-0	1225-0
Input Cable Min.	[mm ²]	16.0	25.0	25.0	35.0	70.0	70.0
	[awg]	5	3	3	2	-2	-2
Input Cable Max.	[mm ²]	35.0	35.0	35.0	150.0	150.0	150.0
	[awg]	2	2	2	-5	-5	-5
Output Cable Min.	[mm ²]	16.0	25.0	25.0	50.0	70.0	95.0
	[awg]	5	3	3	0	-2	-3
Output Cable Max.	[mm ²]	35.0	35.0	35.0	150.0	150.0	150.0
	[awg]	2	2	2	-5	-5	-5
Weight	[kg]	17.0	22.0	22.0	75.0	75.0	75.0
	[lbs]	37.0	48.0	48.0	165.0	165.0	165.0
Dimensions	w [mm]	275.0	275.0	275.0	350.0	350.0	350.0
	h [mm]	520.0	650.0	650.0	1150.0	1150.0	1150.0
	d [mm]	245.0	245.0	245.0	320.0	320.0	320.0
	w [inches]	10.83	10.83	10.83	13.78	13.78	13.78
	h [inches]	20.47	25.59	25.59	45.28	45.28	45.28
	d [inches]	9.65	9.65	9.65	12.6	12.6	12.6

Input voltage range 3 AC 380 V – 480 V, ± 10 % (Unfiltered), Part 1

Order No.	6SE6430 -	2UD27- 5CA0	2UD31- 1CA0	2UD31- 5CA0	2UD31- 8DA0	2UD32- 2DA0
Motor Output Rating	[kW]	7.5	11.0	15.0	18.5	22.0
	[hp]	10.0	15.0	20.0	25.0	30.0
Output Power	[kVA]	10.1	14.0	19.8	24.4	29.0
VT Input Current	[A]	16.0	22.5	30.5	37.2	43.3
VT Output Cur. Max.	[A]	18.4	26.0	32.0	38.0	45.0
Recommended Fuse	[A]	20	32	35	50	63
		3NA3007	3NA3012	3NA3014	3NA3020	3NA3022
Fuses recommended for UL applications	[A]				50	63
	3NE				1817-0	1818-0
Input Cable Min.	[mm ²]	2.5	4.0	6.0	10.0	10.0
	[awg]	13	11	9	7	7
Input Cable Max.	[mm ²]	10.0	10.0	10.0	35.0	35.0
	[awg]	7	7	7	2	2
Output Cable Min.	[mm ²]	2.5	4.0	6.0	10.0	10.0
	[awg]	13	11	9	7	7
Output Cable Max.	[mm ²]	10.0	10.0	10.0	35.0	35.0
	[awg]	7	7	7	2	2
Weight	[kg]	5.5	5.5	5.5	16.0	16.0
	[lbs]	12.1	12.1	12.1	35.0	35.0
Dimensions	w [mm]	185.0	185.0	185.0	275.0	275.0
	h [mm]	245.0	245.0	245.0	520.0	520.0
	d [mm]	195.0	195.0	195.0	245.0	245.0
	w [inches]	7.28	7.28	7.28	10.83	10.83
	h [inches]	9.65	9.65	9.65	20.47	20.47
	d [inches]	7.68	7.68	7.68	9.65	9.65

Input voltage range 3 AC 380 V – 480 V, ± 10 % (Unfiltered), Part 2

Order No.	6SE6430-	2UD33-0DA0	2UD33-7EA0	2UD34-5EA0	2UD35-5FA0	2UD37-5FA0	2UD38-8FA0
Motor Output Rating	[kW]	30.0	37.0	45.0	55.0	75.0	90.0
	[hp]	40.0	50.0	60.0	75.0	100.0	120.0
Output Power	[kVA]	34.3	47.3	57.2	68.6	83.8	110.5
VT Input Current	[A]	59.3	71.7	86.6	103.6	138.5	168.5
VT Output Cur. Max.	[A]	62.0	75.0	90.0	110.0	145.0	178.0
Recommended Fuse	[A]	80	100	125	160	160	200
		3NA3024	3NA3030	3NA3032	3NA3036	3NA3036	3NA3140
Fuses recommended for UL applications	[A]	80	100	125	160	200	200
	3NE	1820-0	1021-0	1022-0	1224-0	1225-0	1225-0
Input Cable Min.	[mm ²]	16.0	25.0	25.0	35.0	70.0	70.0
	[awg]	5	3	3	2	-2	-2
Input Cable Max.	[mm ²]	35.0	35.0	35.0	150.0	150.0	150.0
	[awg]	2	2	2	-5	-5	-5
Output Cable Min.	[mm ²]	16.0	25.0	25.0	35.0	70.0	95.0
	[awg]	5	3	3	2	-2	-3
Output Cable Max.	[mm ²]	35.0	35.0	35.0	150.0	150.0	150.0
	[awg]	2	2	2	-5	-5	-5
Weight	[kg]	16.0	20.0	20.0	56.0	56.0	56.0
	[lbs]	35.0	44.0	44.0	123.0	123.0	123.0
Dimensions	w [mm]	275.0	275.0	275.0	350.0	350.0	350.0
	h [mm]	520.0	650.0	650.0	850.0	850.0	850.0
	d [mm]	245.0	245.0	245.0	320.0	320.0	320.0
	w [inches]	10.83	10.83	10.83	13.78	13.78	13.78
	h [inches]	20.47	25.59	25.59	33.46	33.46	33.46
	d [inches]	9.65	9.65	9.65	12.6	12.6	12.6

8 Options

An overview of the options available for the MICROMASTER 430 is given in this section. For further information about options, please refer to the catalog or the documentation CD.

8.1 Device-independent options

- Basic Operator Panel 2 (BOP-2)
- PROFIBUS module
- PC to inverter connection kit
- PC connection kit
- BOP/AOP door mounting kit for single inverter control
- "DriveMonitor" and "Starter" commissioning tool

8.2 Device-dependent options

- EMC filter, Class A
- EMC filter, Class B (Frame size C)
- Line commutating choke
- Output choke
- Gland plate

9 Electro-magnetic compatibility (EMC)

This Chapter contains:

EMC information.

9.1	Electro-magnetic compatibility	94
-----	--------------------------------------	----

9.1 Electro-magnetic compatibility

(EMC) All manufacturers / assemblers of electrical apparatus which “performs a complete intrinsic function and is placed on the market as a single unit intended for the end user” must comply with the EMC directive 89/336/EEC.

There are three routes for the manufacturer/assembler to demonstrate compliance:

9.1.1 Self-certification

This is a manufacturer's declaration that the European standards applicable to the electrical environment for which the apparatus is intended have been met. Only standards that have been officially published in the Official Journal of the European Community can be cited in the manufacturer's declaration.

9.1.2 Technical construction file

A technical construction file can be prepared for the apparatus describing its EMC characteristics. This file must be approved by a ‘Competent Body’ appointed by the appropriate European government organization. This approach allows the use of standards that are still in preparation.

9.1.3 EC type examination certificate

This approach is only applicable to radio communication transmitting apparatus. All MICROMASTER units are certified for compliance with the EMC directive, when installed in accordance with the recommendations in Section 2.

9.1.4 EMC Directive Compliance with Imminent Harmonics Regulations

Since 1st January 2001 all electrical apparatus covered by the EMC Directive will have to comply with EN 61000-3-2 "Limits for harmonic current emissions (equipment input ≤ 16 A per phase)".

All Siemens variable speed drives of the MICROMASTER, MIDIMASTER, MICROMASTER Eco and COMBIMASTER ranges, which are classified as "Professional Equipment" within the terms of the standard, fulfill the requirements of the standard.

The allowed harmonic currents for “professional equipment” with an input power > 1 kW are not yet defined. Therefore, any electrical apparatus containing the above drives which has an input power > 1 kW will not require connection approval.

9.1.5 Classification of EMC performance

Three General classes of EMC performance are available as detailed below:

Class 1: General Industrial

Compliance with the EMC Product Standard for Power Drive Systems EN 68100-3 for use in **Second Environment (Industrial)** and **Restricted Distribution**.

Table 9-1 General Industrial
(unfiltered inverters together with approved external mains filter)

EMC Phenomenon	Standard	Level
Emissions:		
Radiated Emissions	EN 55011	Limit A1
Conducted Emissions	EN 55011	Limit A1
Immunity:		
Electrostatic Discharge	EN 61000-4-2	8 kV air discharge
Burst Interference	EN 61000-4-4	2 kV power cables, 1 kV control
Radio Frequency Electromagnetic Field	IEC 1000-4-3	26-1000 MHz, 10 V/m

Class 2: Filtered Industrial

This level of performance will allow the manufacturer/assembler to self-certify their apparatus for compliance with the EMC directive for the industrial environment as regards the EMC performance characteristics of the power drive system. Performance limits are as specified in the Generic Industrial Emissions and Immunity standards EN 50081-2 and EN 50082-2.

Table 9-2 Filtered Industrial

EMC Phenomenon	Standard	Level
Emissions:		
Radiated Emissions	EN 55011	Limit A1
Conducted Emissions	EN 55011	Limit A1
Immunity:		
Supply Voltage Distortion	IEC 1000-2-4 (1993)	
Voltage Fluctuations, Dips, Unbalance, Frequency Variations	IEC 1000-2-1	
Magnetic Fields	EN 61000-4-8	50 Hz, 30 A/m
Electrostatic Discharge	EN 61000-4-2	8 kV air discharge
Burst Interference	EN 61000-4-4	2 kV power cables, 2 kV control
Radio Frequency Electromagnetic Field, amplitude modulated	ENV 50 140	80-1000 MHz, 10 V/m, 80% AM, power and signal lines
Radio-frequency Electromagnetic Field, pulse modulated	ENV 50 204	900 MHz, 10 V/m 50% duty cycle, 200 Hz repetition rate

Class 3: Filtered - for residential, commercial and light industry

This level of performance will allow the manufacturer / assembler to self-certify compliance of their apparatus with the EMC directive for the residential, commercial and light industrial environment as regards the EMC performance characteristics of the power drive system. Performance limits are as specified in the generic emission and immunity standards EN 50081-1 and EN 50082-1.

Table 9-3 Filtered for Residential, Commercial and Light Industry

EMC Phenomenon	Standard	Level
Emissions:		
Radiated Emissions*	EN 55011	Limit B
Conducted Emissions	EN 55011	Limit B
Immunity:		
Supply Voltage Distortion	IEC 1000-2-4 (1993)	
Voltage Fluctuations, Dips, Unbalance, Frequency Variations	IEC 1000-2-1	
Magnetic Fields	EN 61000-4-8	50 Hz, 30 A/m
Electrostatic Discharge	EN 61000-4-2	8 kV air discharge
Burst Interference	EN 61000-4-4	2 kV power cables, 2 kV control
Radio Frequency Electromagnetic Field, amplitude modulated	ENV 50 140	80-1000 MHz, 10 V/m, 80% AM, power and signal lines
Radio-frequency Electromagnetic Field, pulse modulated	ENV 50 204	900 MHz, 10 V/m 50% duty cycle, 200 Hz repetition rate

* These limits are dependent on the inverter being correctly installed inside a metallic switchgear enclosure. The limits will not be met if the inverter is not enclosed.

Notes

- To achieve these performance levels, you must not exceed the default Pulse frequency nor use cables longer than 25 m.
- The MICROMASTER inverters are intended **exclusively for professional applications**. Therefore, they do not fall within the scope of the harmonics emissions specification EN 61000-3-2.
- Maximum mains supply voltage when filters are fitted is 480 V.

Table 9-4 Compliance Table

Model	Remarks
Class 1 – General Industrial	
6SE6430-2U***-**A0	Unfiltered units, all voltages and powers.
Class 2 – Filtered Industrial	
6SE6430-2A***-**A0	All units with integral Class A filters
Class 3 – Filtered for residential, commercial and light industry	
6SE6430-2U***-**A0 with 6SE6400-2FB0*-***0	Unfiltered units fitted with external Class B footprint filters.
* denotes any value is allowed.	

Appendices

A Changing the Operator Panel

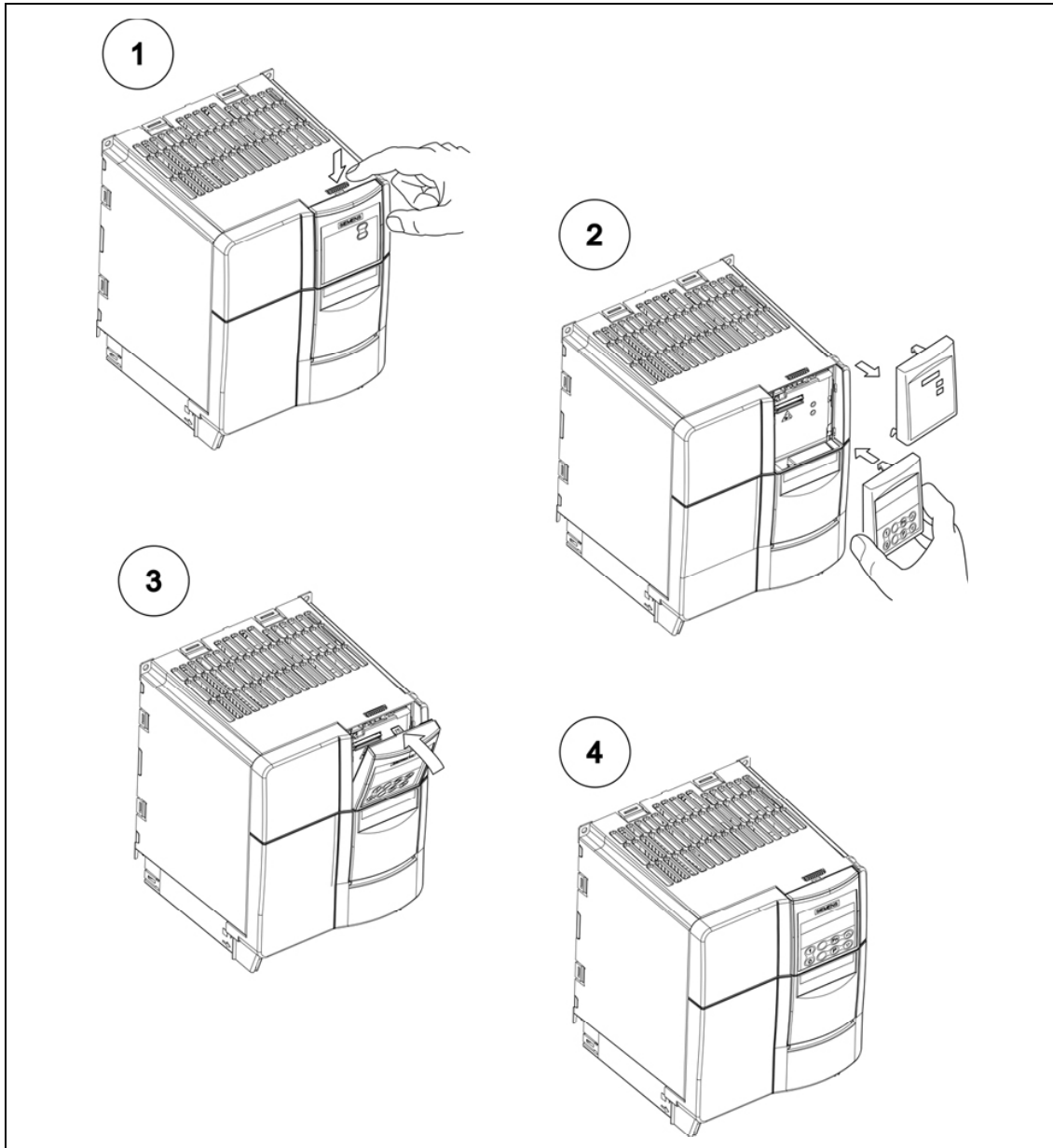

B Removing Covers Frame Size C

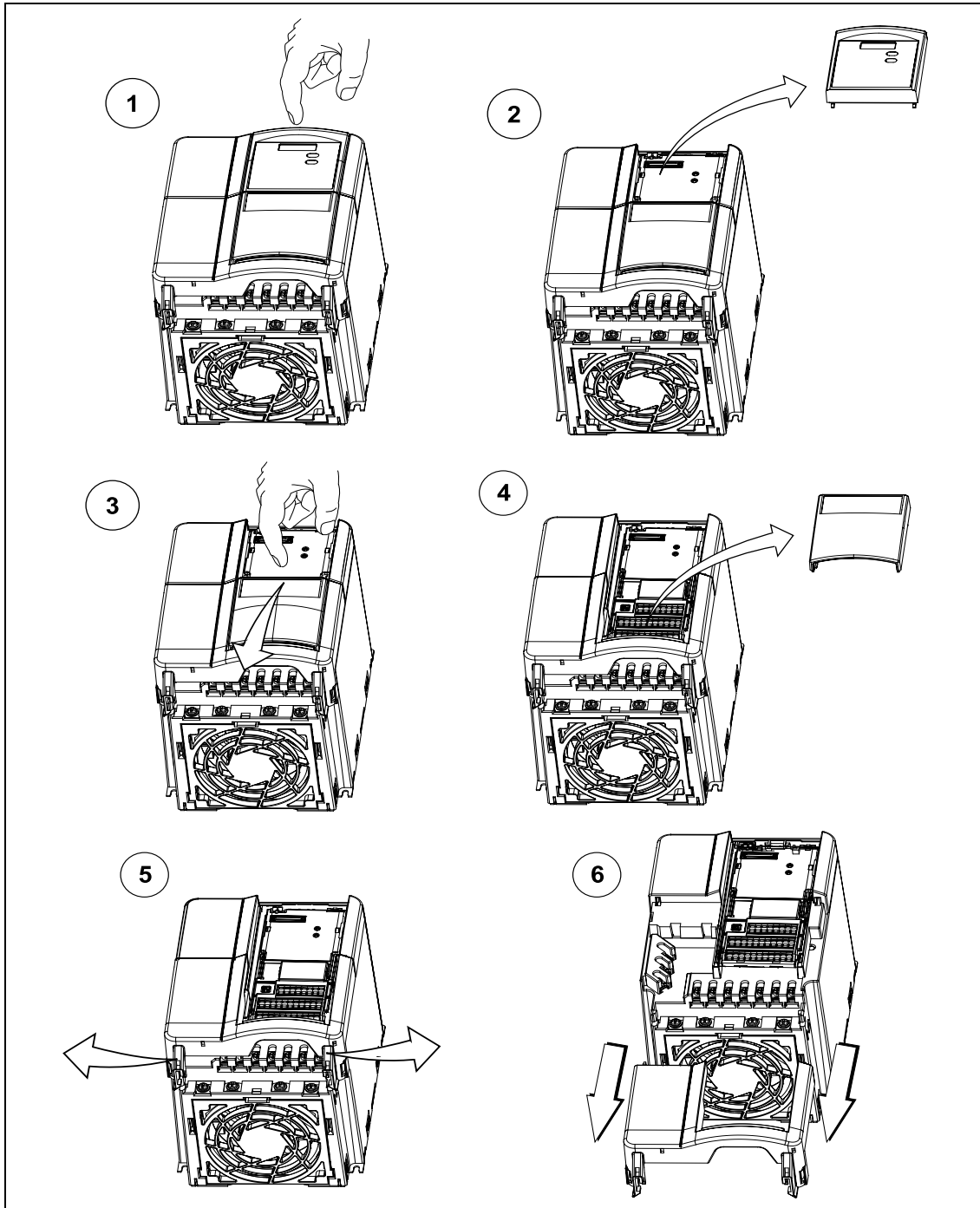

C Removing Covers Frame Sizes D and E

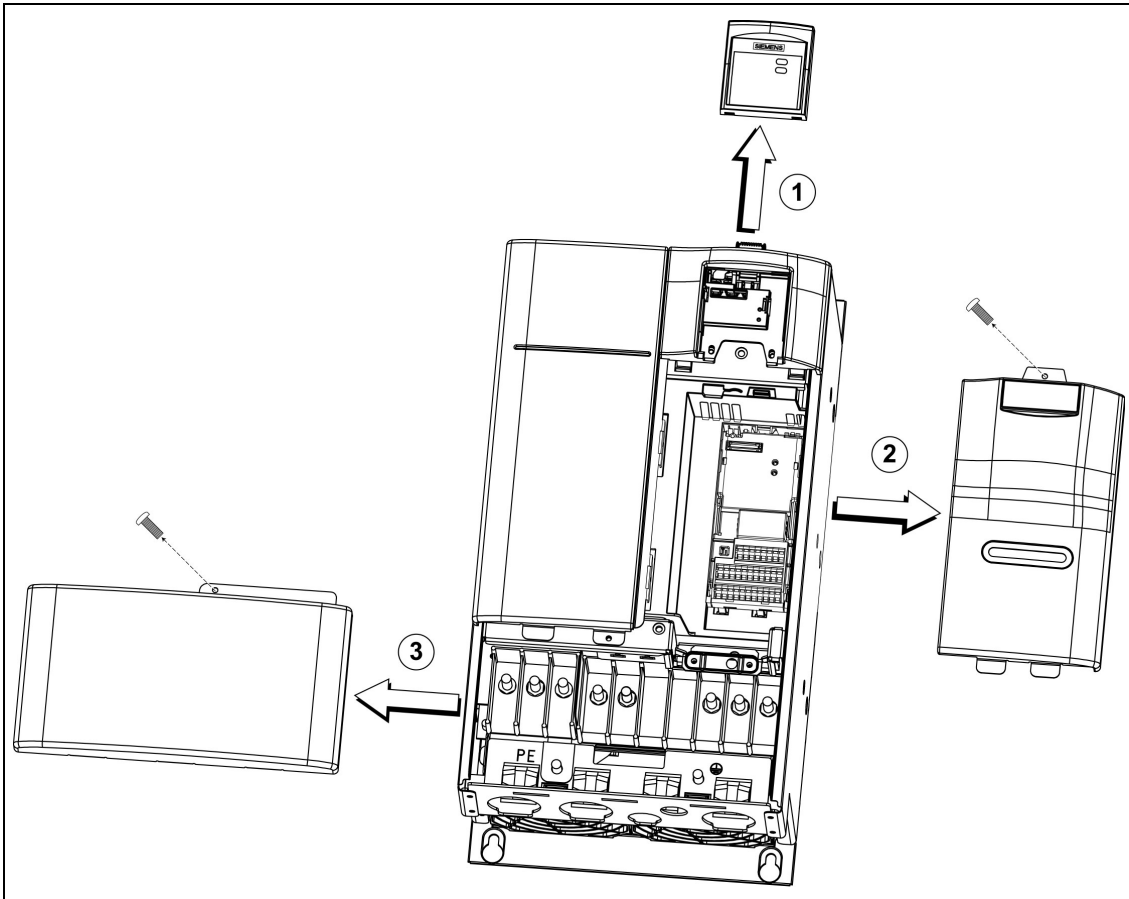

D Removing Covers Frame Size F

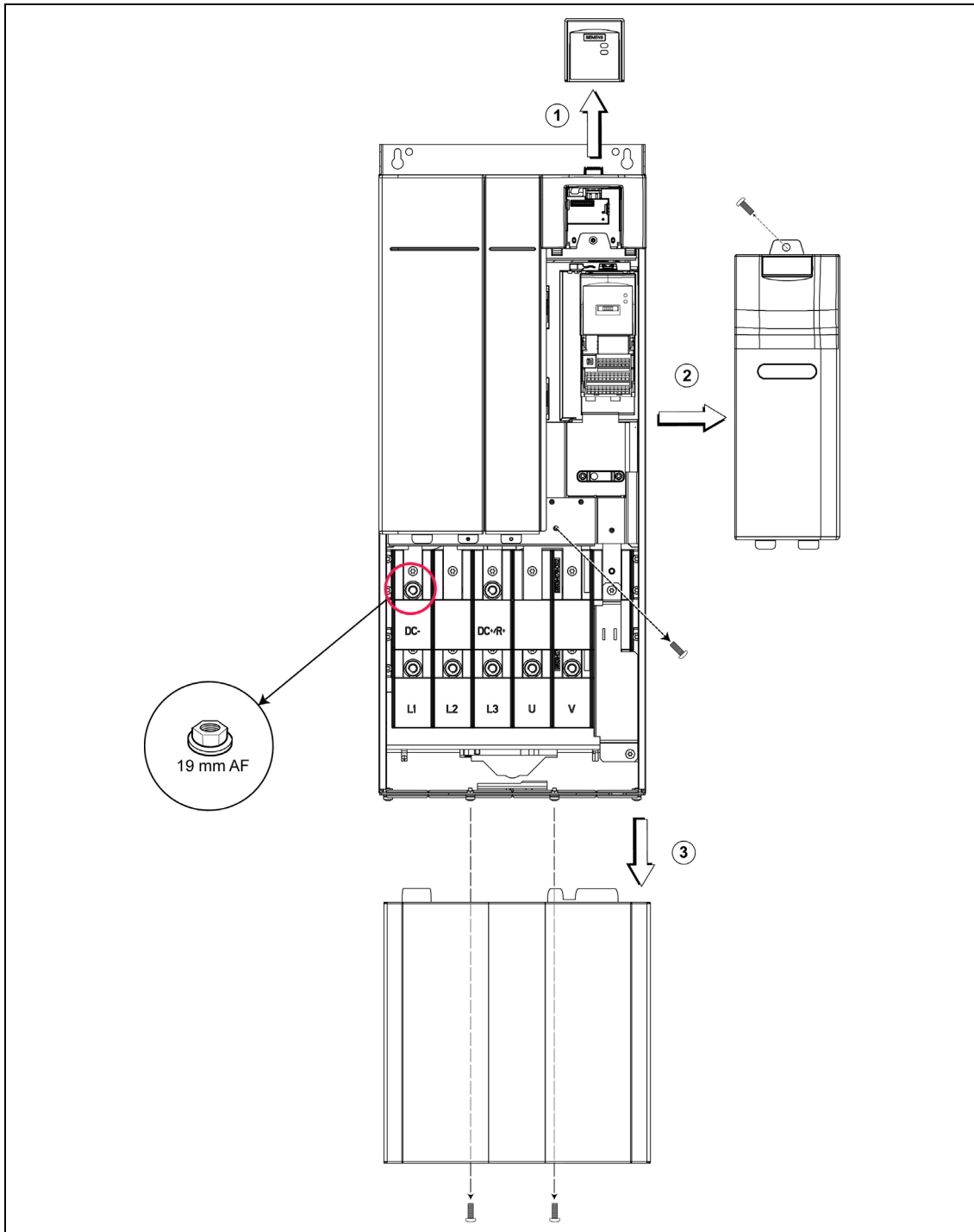

E Removing the I/O Board

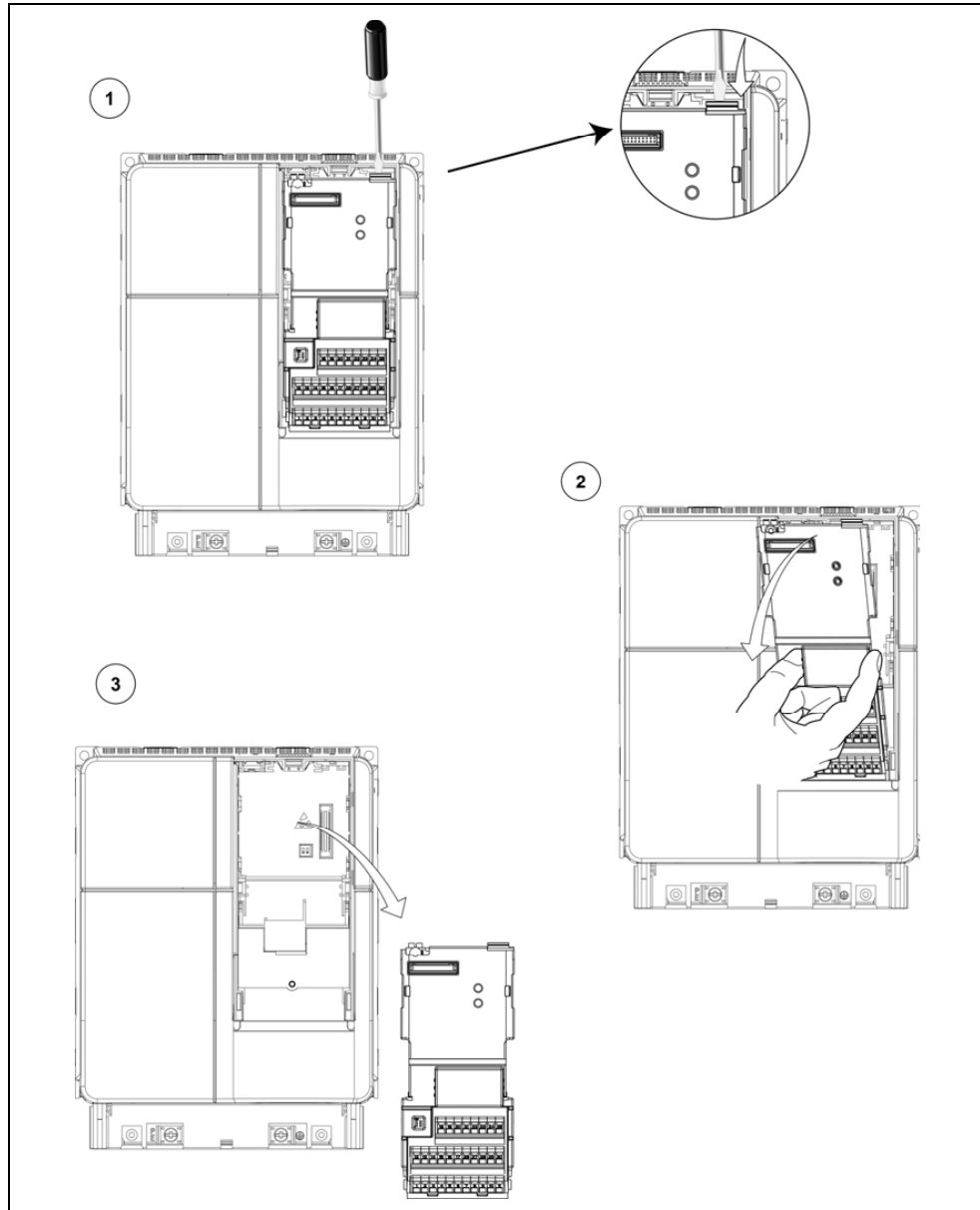

NOTICE

1. Only a small amount of pressure is required to release the I/O Board catch.
 2. Currently, the I/O Board is removed using the same technique regardless of frame size.
-

F Removing 'Y' Cap Frame Size C

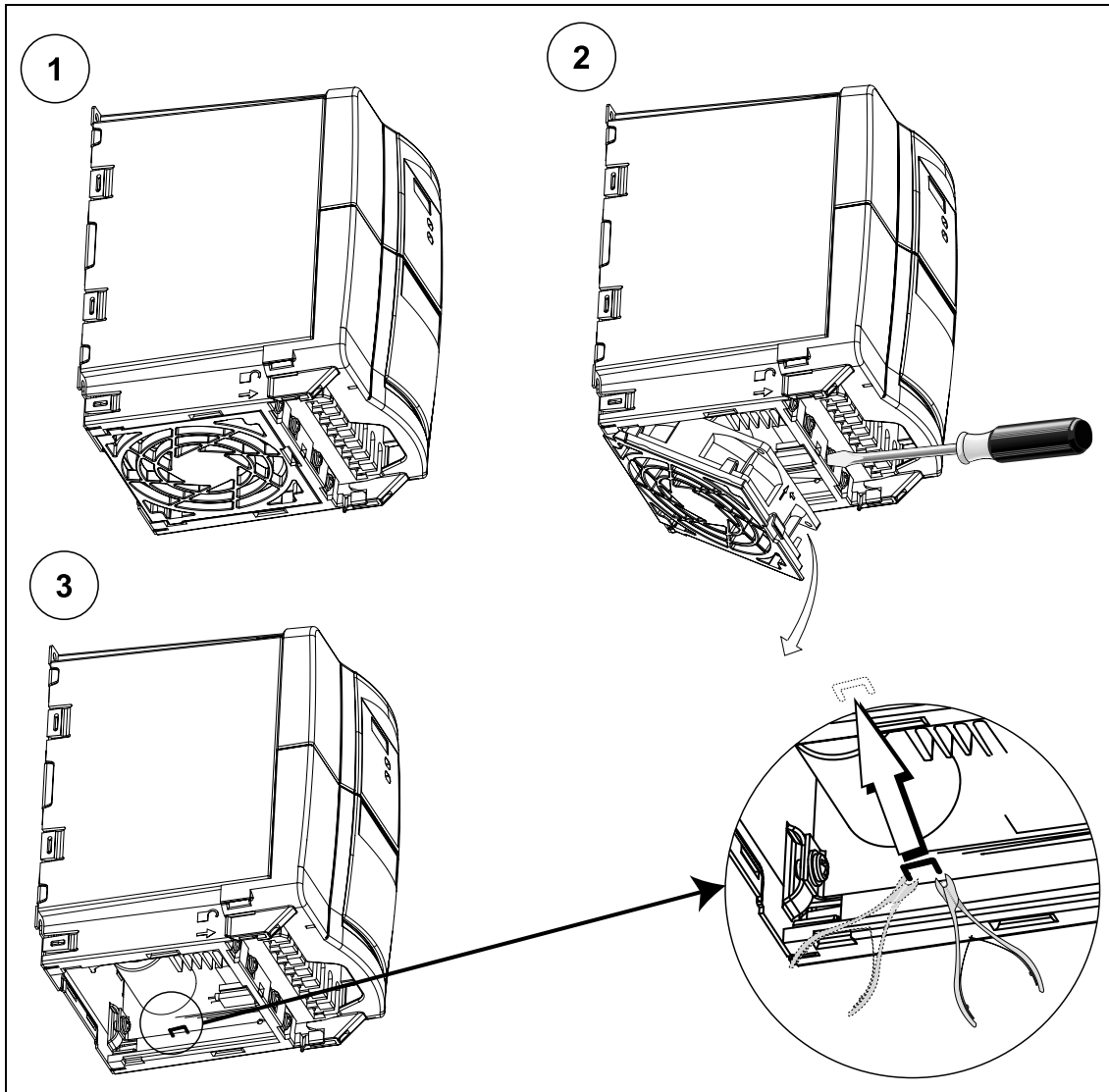

G Removing 'Y' Cap Frame Sizes D and E

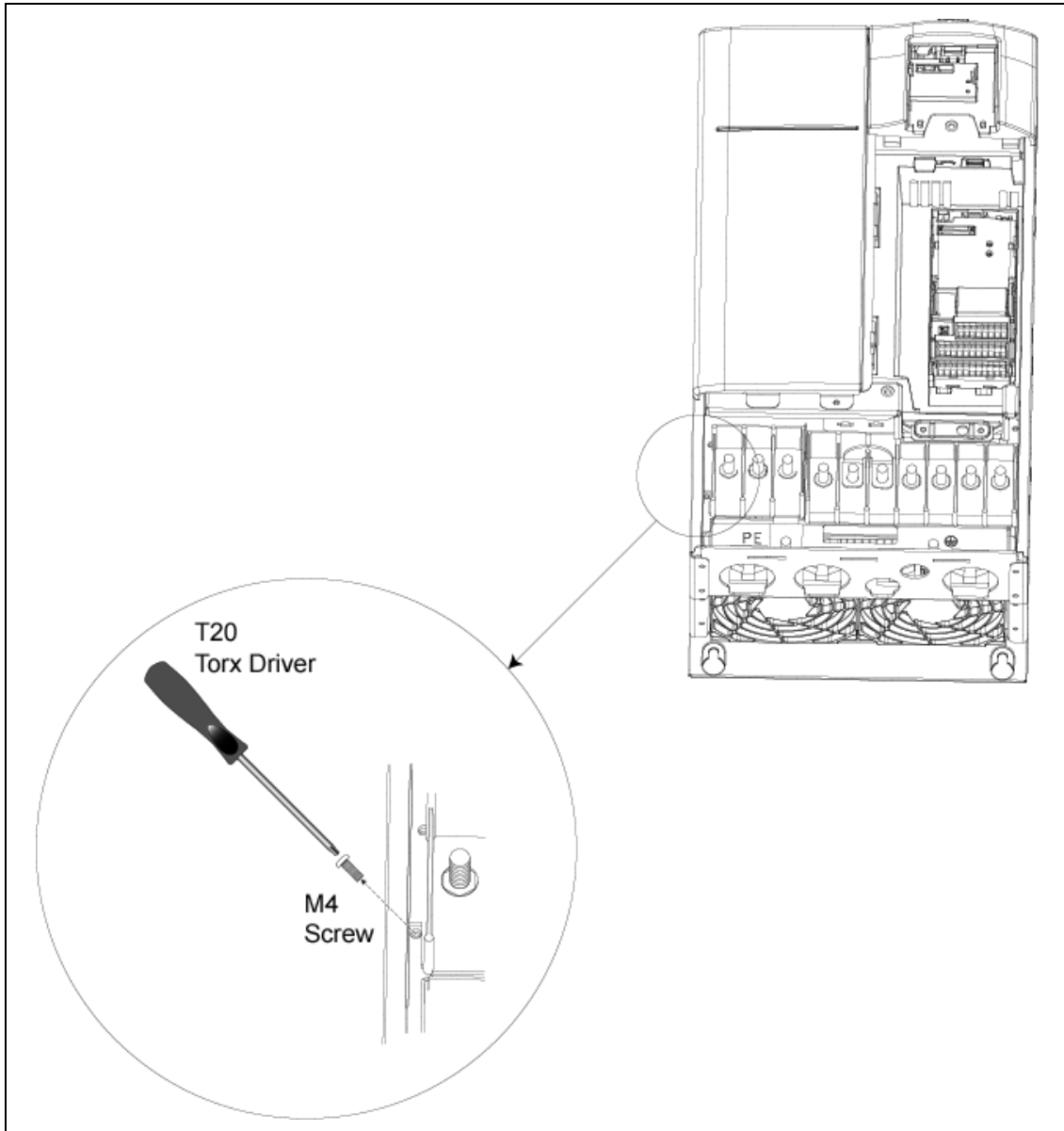

H Removing 'Y' Cap Frame Sizes F

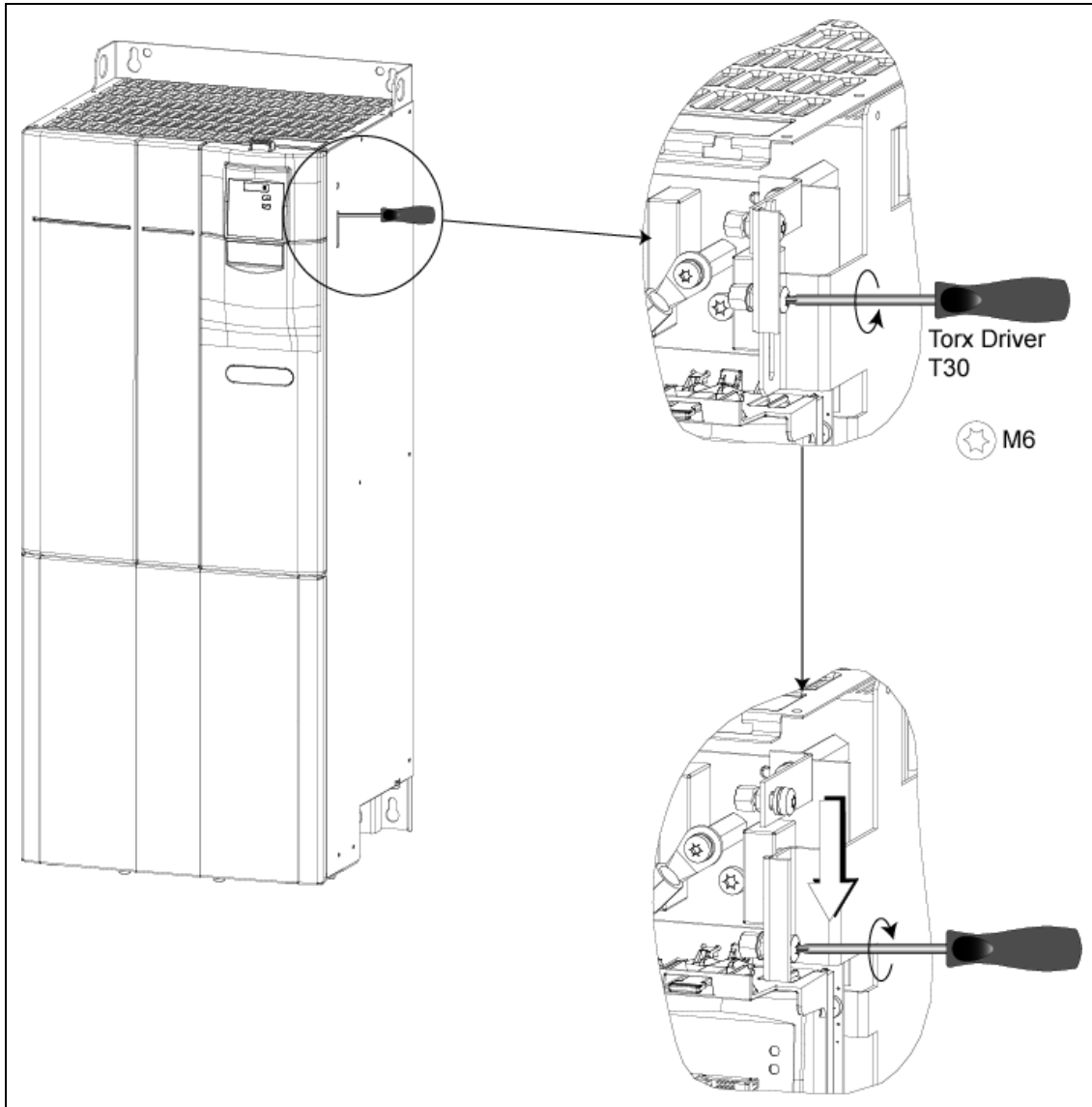

I Applicable Standards



European Low Voltage Directive

The MICROMASTER product range complies with the requirements of the Low Voltage Directive 73/23/EEC as amended by Directive 98/68/EEC. The units are certified for compliance with the following standards:

EN 60146-1-1 Semiconductor inverters – General requirements and line commutated inverters

EN 60204-1 Safety of machinery - Electrical equipment of machines

European Machinery Directive

The MICROMASTER inverter series does not fall under the scope of the Machinery Directive. However, the products have been fully evaluated for compliance with the essential Health & Safety requirements of the directive when used in a typical machine application. A Declaration of Incorporation is available on request.

European EMC Directive

When installed according to the recommendations described in this manual, the MICROMASTER fulfils all requirements of the EMC Directive as defined by the EMC Product Standard for Power Drive Systems EN 61800-3.



Underwriters Laboratories

UL and CUL LISTED POWER CONVERSION EQUIPMENT 5B33 for use in a pollution degree 2

ISO 9001

Siemens plc operates a quality management system, which complies with the requirements of ISO 9001.

J List of Abbreviations

AC	Alternating Current
AIN	Analog Input
BOP-2	Basic Operator Panel 2
DC	Direct Current
DIN	(Digital Input
DS	Drive State
EEC	European Economic Community
ELCB	Earth Leakage Circuit Breaker
EMC	Electro-Magnetic Compatibility
EMI	Electro-Magnetic Interference
FAQ	Frequently Asked Questions
FCC	Flux Current Control
FCL	Fast Current Limitation
I/O	Input and Output
IGBT	Insulated Gate Bipolar Transistor
LCD	Liquid Crystal Display
LED	Light Emitting Diode
PID	Proportional, Integral und Differential
PLC	Programmable Logic Controller
PTC	Positive Temperature Coefficient
QC	Quick Commissioning
RCCB	Residual Current Circuit Breaker
RCD	Residual Current Device
RPM	Revolutions Per Minute
SDP	Status Display Panel
VT	Variable Torque

Index

A

- Access Levels · 58
- Altitude · 22
- Ambient operating conditions
 - Altitude · 22
 - Atmospheric Pollution · 22
 - Electromagnetic Radiation · 22
 - Humidity Range · 22
 - Installation und Kühlung · 22
 - Shock · 22
 - Temperature · 21
 - Vibration · 22
 - Water hazard · 22
- Ambient operating conditions · 21
- Applicable standards
 - European EMC Directive · 105
 - European Low Voltage Directive · 105
 - European Machinery Directive · 105
 - ISO 9001 · 105
 - Underwriters Laboratories · 105
- Atmospheric pollution · 22

B

- Basic operation
 - changing parameters with BOP-2 · 40
 - external motor thermal overload protection · 44, 46
 - general · 45
 - with BOP-2 · 45
 - with SDP · 36
- Belt Failure Detection · 53
- BOP-2
 - default settings with BOP-2 · 38
 - operation with BOP-2 · 38
- Bypass Mode · 52

C

- Commissioning · 31
- Compound braking · 50
- Connection Terminals · 27
- Contact address · 5
- Control modes · 51

D

- DC braking · 50

- Default settings · 38
- Dimensions and Torques · 23
- Drill pattern for MICROMASTER 430 · 24

E

- Electrical Installation · 25
- Electro-Magnetic Compatibility
 - EC type-examination certificate · 94
 - general · 93, 94
 - self-certification · 94
 - technical construction file · 94
- Electro-Magnetic Interference · 29
 - avoiding EMI · 29
- Electromagnetic radiation · 22
- EMC · 94
- EMC Directive Compliance · 94
- EMC performance
 - filtered for residential, commercial and light industry · 96
 - filtered industrial class · 95
 - general industrial class · 95
- EMI · 29
- Energy Saving Mode · 55

F

- Fault messages
 - with the BOP-2 fitted · 75
 - with the SDP fitted · 74
- Faults and Alarms
 - with BOP-2 · 56
 - with SDP · 56
- Features · 17
- flux current control (FCC) · 51
- Foreword · 5
- Frequency set point · 48

H

- Humidity Range · 22

I

- Installation · 19
 - after a period of storage · 21
- Installation und Kühlung · 22
- Internet Home Address · 5

Inverter block diagram · 33

L

Linear U/f control · 51

Long cables
operation with · 26

M

Main characteristics · 17

Mechanical Installation · 23

MICROMASTER 430

general · 16
main characteristics · 17
performance characteristics · 18
protection characteristics · 18
specifications · 85

Motor connections · 26

Motor data · 44

Motor Staging · 54

Multiple point U/f control · 51

O

Operation

OFF and brake function · 49

Operation with

long cables · 26
Residual Current Device · 25
ungrounded IT supplies · 25

Operator panels

BOP-2 · 38
changing the operator panel · 97
SDP · 35

Options

Device-dependent options · 91
Device-independent options · 91

Overview · 15

P

Parabolic U/f control · 51

Parameter

Systemparameter · 57

Parameters

changing parameters with BOP-2 · 40

Performance characteristics · 18

Performance Ratings · 86

Power and motor connections · 26

Protection characteristics · 18

Q

Qualified personnel · 6

Quick commissioning · 41

R

Removing 'Y' Cap Frame Sizes C · 102

Removing 'Y' Cap Frame Sizes D and E ·
103

Removing 'Y' Cap Frame Sizes F · 104

Removing Covers Frame Size C · 98

Removing Covers Frame Size F · 100

Removing Covers Frame Sizes D and E ·
99

Removing the I/O Board · 101

Reset to Factory default · 44

Residual Current Device
operation with · 25

S

Safety instructions · 7

Screening Methods · 30

SDP

Default settings · 35
operation with SDP · 35

Shock · 22

Specifications · 87

T

Technical Support · 5

Troubleshooting · 73

U

Ungrounded (IT) supplies
operation with · 25

W

Warnings, cautions & notes
commissioning · 8

definitions · 6

dismantling & disposal · 9

general · 7

operation · 9

repair · 9

transport & storage · 8

Water hazard · 22

Wire Sizes & Terminal Torques · 87

Wiring Guidelines EMI · 30

Suggestions and/or Corrections

<p>To: Siemens AG Automation & Drives Group SD VM 4 P.O. Box 3269 D-91050 Erlangen Federal Republic of Germany Email: Technical.documentation@con.siemens.co.uk</p>	<p>Suggestions</p> <hr/> <p>Corrections</p> <p>For Publication/Manual: MICROMASTER 430</p> <p>User Documentation</p>
<p>From</p> <p>Name: _____</p> <p>Company/Service Department _____</p> <p>Address: _____ _____</p> <p>Telephone: _____ / _____</p> <p>Telefax: _____ / _____</p>	<p>Operating Instructions</p> <p>Order Number: 6SE6400-5AC00-0BP0</p> <p>Date of Issue: 12/01</p> <p>Should you come across any printing errors when reading this publication, please notify us on this sheet.</p> <p>Suggestions for improvement are also welcome.</p>

Order Number

6SE6400-5AC00-0BP0

Drawing Number

G85139-K1790-U249-A1

Siemens AG
Bereich Automation and Drives (A&D)
Geschäftsgebiet Standard Drives (SD)
Postfach 3269, D-91050 Erlangen
Federal Republic of Germany

© Siemens AG, 2001
Subject to change without prior notice

Siemens Aktiengesellschaft

Order No.: 6SE6400-5AC00-0BP0
Date: 03/02

